

PROPERTY OF AFAZ, YVE

technical manual for model S-37 radio receiver

Guarantee

This receiver is guaranteed to be free from any defect in workmanship and material that may develop within a period of ninety (90) days from date of purchase, under the terms of the standard guarantee as designated by the Radio Manufacturers Association. Any part or parts that prove defective within this period will be replaced without charge when subjected to examination at our factory, providing such defect, in our opinion, is due to faulty material or workmanship, and not caused by tampering, abuse or normal wear. All such adjustments to be made F.O.B. the factory.

Should this receiver require any adjustments, your dealer or distributor has complete technical service information, or the factory will be glad to assist you

In any problem direct

Should it be necessary to return any part or parts to the factory, a "Return Material Permit" must be obtained in advance by first writing the Adjustment Department, who will issue this authorization under the terms of the guarantee.

The Hallicrafters Co. reserves the right to make changes in design or add improvements to instruments manufactured by them, without incurring any obligation to install the same in any instrument previously purchased.

All Hallicrafters receivers are built under patents of Radio Corporation of America and Hazeltine Corporation.

hallicrafters RADIO

THE HALLCRAFTERS COMPANY, MANUFACTURERS

RADIO AND ELECTRONIC EQUIPMENT, CHICAGO, ILL., U.S.A.

TABLE OF CONTENTS

Subject	Page
I DESCRIPTION	
1. General	1-1
2. Description Of Main Components.	1-1
3. Frequency Coverage.	1-1
4. Power Requirements.	1-2
5. Main Components - Weights And Dimensions.	1-2
II INSTALLATION AND ADJUSTMENT	
1. Installation.	2-1
2. Preparation For Use	2-2
3. Adjustment.	2-3
III OPERATION	
1. Controls And Their Functions.	3-1
2. Operation	3-2
3. Station Logging	3-3
IV FUNCTIONING OF PARTS	
1. General	4-0
2. Detailed Functioning By Stages.	4-0
V MAINTENANCE	
1. Preventive Maintenance.	5-0
2. Replacing Tubes, Lamps, and Fuses	5-0
3. Periodic Adjustments.	5-1
4. Locating Faults With A Volt-Ohm Meter	5-5
VI SUPPLEMENTARY DATA	
1. Frequency Range	6-1
2. Power Input	6-1
3. Audio Power Output.	6-1
4. Sensitivity	6-1
5. Signal To Noise Ratio	6-1
6. Audio Fidelity.	6-1
7. Image Ratio	6-1
8. Selectivity	6-1
9. Overall Weight.	6-1
10. Overall Dimensions.	6-1
VII DRAWINGS	
VIII PARTS LIST	

LIST OF ILLUSTRATIONS

Figure	Title	Page
1-1.	Radio Receiver Model S-37, front view.	iv
2-1.	Radio Receiver Model S-37, wiring diagram for d-c power plug	2-2
4-1.	Radio Receiver Model S-37, block diagram	4-0
5-1.	Radio Receiver Model S-37, top view showing alignment points	5-2
5-2.	Radio Receiver Model S-37, voltage chart	5-6
5-3.	Radio Receiver Model S-37, resistance chart.	5-7
7-1.	Radio Receiver Model S-37, top view.	7-0
7-2.	Radio Receiver Model S-37, bottom view	7-1
7-3.	Radio Receiver Model S-37, rear view	7-2
7-4.	Radio Receiver Model S-37, outline dimensions.	7-3
7-5.	Radio Receiver Model S-37, recommended antenna installations	7-4
7-6.	Radio Receiver Model S-37, tube socket connections	7-5
7-7.	Radio Receiver Model S-37, schematic wiring diagram.	7-7



Figure 1-1. Radio Receiver Model S-37, front view.

SECTION I DESCRIPTION

1. GENERAL

The Model S-37 radio receiver (Fig. 1-1.) is a very high frequency superheterodyne receiver which accepts either amplitude-modulated (A-M) or frequency-modulated (F-M) signals in the 130 to 210 megacycle frequency range. The unit may be operated with its internal power supply from a 115-volt or 230-volt, 50/60 cycle single phase source or from an external supply which will provide direct current at 6.3-volts and 270-volts. The receiver is self contained except for headset, speaker, and antenna. It is normally supplied with a sheet steel cabinet for table top installation as shown, although the receiver chassis assembly may be removed from the cabinet and mounted directly onto a standard rack without any mechanical alterations.

2. DESCRIPTION OF MAIN COMPONENTS

a. Model S-37 Radio Receiver. - The receiver is housed in an all metal well ventilated cabinet with a hinged lid that provides access to all tubes and adjustments with the exception of four acorn tubes that are made accessible by removing the shield cover on the r-f section. The following controls, all plainly marked, are located on the front panel: R.F. GAIN, ANTENNA, A.F. GAIN, TUNING, A.M./F.M., TONE. In addition to the controls, there are four toggle switches marked for the circuits in which they are used, namely, POWER, A.V.C., A.N.L., and SEND/REC. The meter in the upper right hand corner of the panel provides a visual indication of the relative signal strength for a-m reception and aids in centering the carrier for f-m reception. The frequency of reception is read directly from the inner scale of the main tuning dial located to the left of the TUNING control. The outer logging scale operates in conjunction with the vernier logging dial located just above the TUNING control. All external connections, with the exception of the phones, are made at the rear of the chassis. They are: A-C power input, external stand-by switch connection, 500- and 5000-ohm speaker output, d-c power input and antenna and ground connections. The two fuses are also located on the back chassis apron.

b. Tube Complement

Symbol	Tube Type	Function
V-1	954	1st r-f amplifier
V-2	954	2nd r-f amplifier
V-3	954	Mixer
V-4	6AC7	1st i-f amplifier
V-5	6AB7	2nd i-f amplifier
V-6	6SK7	3rd i-f amplifier
V-7	6H6	A-M detector and noise limiter
V-8	6AC7	F-M limiter
V-9	6H6	F-M discriminator
V-10	6SL7GT	Audio voltage amplifier
V-11	6V6GT/G	Audio power amplifier
V-12	OD3/VR-150	Voltage regulator
V-13	5U4G	Rectifier
V-14	955	High-frequency oscillator

3. FREQUENCY COVERAGE

The Model S-37 radio receiver provides continuous coverage over the frequency range 130 to 210 megacycles.

4. POWER REQUIREMENTS

The receiver is designed to operate from either a 115-volt or 230-volt 50/60 cycle, single phase, a-c source or from a 6-volt storage battery and 270-volts of "B" battery. The "B" batteries may be replaced by a suitable vibrator type power supply if it meets the following current requirements.

A-C Operation	* D-C Operation
Line Voltage.....117 volts, 230 volts. Line Current.....1.0 amp, 0.5 amp. Power Consumption..110 watts.	Filament voltage..... 6.3 volts. Filament current..... 3.6 amps. "B" voltage..... 270 volts. "B" current..... 125 ma.

* The 6-volt battery drain using a vibrator type supply for "B" voltage will run approximately 18-20 amperes.

5. MAIN COMPONENTS - WEIGHTS AND DIMENSIONS

Component	Dimensions (inches)			Weight (lbs.)
	Height	Width	Depth	
Model S-37 Radio Receiver	9-3/8	19-1/8	16-1/4	80
Receiver chassis only	8-3/4	19	16-1/4	63

SECTION II

INSTALLATION AND ADJUSTMENT

1. INSTALLATION

a. **Unpacking.** - Carefully unpack and inspect the equipment for any possible damage during shipment. In case of damages, a claim should be filed immediately with the transportation company.

b. **Mounting.** - The receiver as supplied is designed for table top operation, hence is equipped with rubber feet. The alternate rack mounting installation requires the removal of the chassis assembly from the cabinet before installing the unit in the rack. A chassis bottom plate and dust cover are recommended for this type of installation.

c. **Antenna Recommendations.** - Three terminals are provided on the antenna terminal strip located at the rear of the r-f amplifier section housing. Terminals A₁ and A₂ are connected to the primary winding of the first r-f stage transformer and the GND terminal is connected to the receiver's ground system.

(1) **Single Wire Antenna.** - When using a single wire antenna installation, connect a jumper between the receiver terminals A₂ and GND. A single wire antenna of about 50 to 75 feet (including lead-in) is then connected to terminal A₁. This type of antenna works well where the signal to noise ratio is relatively high and a more elaborate installation is not available. Erect the antenna as high and free from surrounding objects as possible. Refer to Fig. 7-5.

(2) **Doublet Antenna.** - The doublet antenna is recommended where receiving conditions are difficult or where maximum sensitivity is required over a relatively narrow range of frequencies. The transmission line from the antenna is connected to antenna terminals A₁ and A₂. If a concentric line with a grounded outer conductor is used, connect the inner conductor to terminal A₁ the outer conductor to terminal A₂, and connect a jumper between terminals A₂ and GND. To determine the proper length in inches of the doublet antenna, divide 5540 by the frequency of reception in megacycles. After cutting the wire to the length determined above, cut it in half and insert an insulator at that point. Solder the two wires of the transmission line to each of the quarter wave sections at the insulator. (Refer to Fig. 7-5.) Keep in mind that this type of antenna is directional broadside to its length and should be so orientated if maximum pickup from a given direction is desired. The multiple dipole antenna shown in Fig. 7-5. is a modification of the conventional doublet antenna. Its purpose is to provide good reception over a wider range of frequencies than that obtainable with the single frequency doublet installation.

d. **Audio Output Connections.** - A headset or loudspeaker may be used with the receiver.

(1) The headset jack marked PHONES located on the front panel; provides a high impedance output for headset operation. A headset which has an impedance of 3000 ohms or more will be satisfactory.

(2) The two speaker terminal strips located on the rear chassis apron (Refer to Fig. 7-3.) provide output impedances of 500 and 5000 ohms for loudspeaker reception. One side of each of the 500 and 5000-ohm output connections is grounded and this should be kept in mind if this receiver is to work in conjunction with other equipment. A speaker capable of handling 5 watts of audio power should be used with this equipment.

$$\begin{array}{r}
 144 \overline{) 5540.0} \\
 \underline{432} \\
 1220 \\
 \underline{1152} \\
 680
 \end{array}$$

38.4 = 38.5" approx.

e. **Remote Operation Facilities.** - The receiver is equipped with a standard a-c outlet receptacle (S0-2) which provides for remote operation of the receiver. To provide remote disabling of this receiver connect a remotely operated switch or relay across the two contacts of the a-c outlet (S0-2) (Refer to Fig. 7-3. for location). When using the remote control disabling switch, the SEND/REC switch on the receiver must be set at SEND.

CAUTION - The external switch and its connections will be approximately 270 volts above ground during stand-by (receiver off) hence should be well insulated throughout.

2. PREPARATION FOR USE

a. **A-C Operation.** - The receiver may be operated from either a 117-volt or 230-volt, 50/60 cycle, single phase, a-c source of power. As supplied the receiver is ordinarily wired for 117-volt operation. To change over for 230-volt operation, disconnect the primary leads (Leads #1 and #2) connected to the 117-volt terminals on transformers T-11 and T-12 and connect them to the 230-volt terminals. Refer to Fig. 7-2.

CAUTION - Check the primary connections before connecting power to the receiver. A receiver wired for 230-volt operation will not be damaged when connected to 117 volts, but a receiver wired for 117 volts will, in most cases, be damaged when plugged into a 230-volt outlet.

b. **D-C Operation.** - The receiver may be operated from a 6-volt d-c source, generally a storage battery, and a 270-volt d-c supply in the form of dry batteries or vibrator type power pack. Consult the chart on power requirements for d-c operation in Section I and provide battery facilities capable of supplying these demands. The receiver is connected to the d-c supply as follows;

(1) Remove the octal "jumper plug" for a-c operation from socket S0-1 located on the rear apron of the receiver chassis.

(2) Wire up an octal plug as shown in Fig. 2-1. and plug it into socket S0-1. Use No. 18 (AWG) wire leads for the 270-volt "B" supply connections to pins #3 and #5 and No 12 (AWG) wire leads for the 6-volt "A" battery connections to pins #1, #8 and #7.

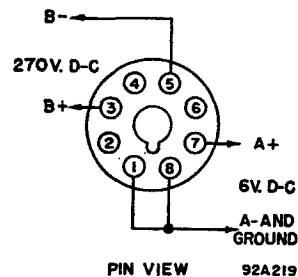

Fig. 2-1. Radio Receiver Model S-37, wiring diagram for d-c power plug.

CAUTION - Check your wiring carefully before connecting up to the battery supply.

c. **Pre-Operational Check.** - The following checkup on a newly installed piece of equipment is recommended before turning on the power for the first time.

(1) See that the tubes are securely seated in their sockets. Refer to Fig. 7-1. for the proper location of each tube. Note - The four acorn type tubes are made accessible by removing the shield cover over the r-f section.

(2) Check the pilot lamps behind the dial and meter escutcheons. See that they are securely in place.

(3) Check the two line fuses (F-1 and F-2) located on the rear apron of the chassis to see that they are in operating order. A visual check is generally sufficient.

(4) Check all external connections to the antenna terminals, speaker terminals, etc. See that they are secure and make positive contact. Remember that an improvised installation gives improvised results.

3. ADJUSTMENT

No preliminary adjustments are required on this equipment to put it into operation as the receiver has been properly aligned and tested at the factory before shipment.

SECTION III

OPERATION

1. CONTROLS AND THEIR FUNCTION

Scanning across the front panel from left to right the control markings and their functions are as follows: (Refer to Fig. 1-1.)

a. **R. F. GAIN Control.** - The radio frequency gain control regulates the sensitivity of the receiver. Turning the control to the right increases the sensitivity of the receiver. Ganged to this control is the "S" meter switch which connects the tuning meter into the circuit when the control is advanced all the way to the right during automatic volume control operation.

b. **POWER Switch.** - The power switch connects the a-c power to the receiver when operating from a-c mains only. When operating the receiver from a battery supply this control function must be handled by a power switch in the battery supply circuit.

CAUTION - When operating the receiver from a d-c supply set the receiver's POWER switch at OFF and do not plug the a-c line cord into an a-c outlet.

c. **ANTENNA Control.** - This control is used to compensate for misalignment of the receiver's antenna stage due to antenna impedance variations. Once set for a given antenna, its setting will hold for a wide range of frequencies.

d. **A.V.C. Switch.** - The automatic volume control switch when set at ON, provides a constant audio output level over reasonable variations in signal strength at the antenna. That is, it automatically controls the sensitivity of the receiver when this circuit is in operation. The A.V.C. switch must be set at ON to use the output meter.

e. **A.F. GAIN Control.** - The audio frequency gain control sets the volume or audio signal level at the speaker or headset. The control is set for a level most pleasing to the operator.

f. **TUNING Control.** - This control tunes the receiver to the desired frequency of reception. The frequency of reception is read directly on the main tuning dial located to the left of the control. The logging dial located directly above the TUNING control is used in conjunction with the LOGGING SCALE (outer scale) of the main tuning dial. Refer to the discussion on logging in this section.

g. **A.N.L. Switch.** - The automatic noise limiter switch cuts in a circuit which clips the noise voltage peaks generated by electrical disturbances, thereby providing intelligible reception in cases where reception would be normally impossible. This feature will not totally remove the noise but will do a good job of limiting it to reasonable levels.

h. **S-METER ADJ.** - This adjustment sets the signal level meter to its zero signal level position when the receiver is set for A.M. (amplitude modulation) reception. The adjustment is made with a screw driver and once set, it is seldom necessary to make further adjustments.

i. **A.M./F.M. Switch.** - This switch changes over the receiver for either amplitude modulation reception (A.M.) or frequency-modulation reception (F.M.).

j. **"S" Meter or Tuning Meter.** - The tuning meter serves two functions in the receiver depending on the type of reception as follows:

(1) **A.M. Reception.** - When the receiver is adjusted to receive amplitude modulated signals, the tuning meter indicates the relative carrier strength of the received signal. To put the meter in operation, turn the R.F. GAIN control to the right until the switch connected to its shaft clicks, and set the A.V.C. switch at ON.

(2) **F.M. Reception.** - When the receiver is adjusted to receive frequency modulated signals, the tuning meter is used to indicate resonance with the station carrier. As the receiver is tuned through the f-m carrier the meter pointer will first deflect to one side of zero, return to zero and deflect an equal distance on the opposite side of zero, and finally return to zero as the carrier is completely passed. The zero center position in the middle of the swing represents the current setting of the receiver tuning dial and indicates resonance with the station carrier.

k. **TONE Control.** - The tone control, as its name implies, adjusts the tone qualities of the aural signal for either the headset or loudspeaker. As the control is turned to the right more and more of the higher frequency components of the audio signal are attenuated. This control will be found useful in cutting down high pitched interference background noises.

l. **SEND/REC. Switch.** - Use this switch for stand-by purposes when the receiver is to be disabled for short periods of time. This switch disconnects the d-c plate voltage from the receiver and leaves the tube heaters at operating temperature for instant use.

m. **PHONES Jack.** - Outlet for headset operation.

2. OPERATION.

Listed below are the receiver controls and their settings for the two types of reception provided by this receiver, namely, amplitude modulation reception and frequency modulation reception.

a. **A.M. (Amplitude Modulation) Reception.** - To receive an amplitude modulated signal, set the panel controls as follows:

- | | | |
|-------------------|---|--|
| POWER switch | - | Set at ON when operating receiver on alternating current. To turn off receiver set switch at off. |
| | | CAUTION - Leave switch set at OFF when operating receiver from external batteries. |
| SEND/REC. switch | - | Set at REC. (Set at SEND to disable receiver when desired.) |
| A.M./F.M. switch | - | Set at A.M. |
| A.V.C. switch | - | Set at ON. |
| R.F. GAIN control | - | Turn to right until switch on control clicks. |
| TUNING control | - | Set dial that is calibrated in megacycles to frequency of signal; adjust for maximum tuning meter reading. |
| ANTENNA control | - | Adjust for maximum tuning meter reading. |
| A.F. GAIN control | - | Adjust for desired signal level at headset or speaker. |
| TONE control | - | Set to please the listener. |
| A.N.L. switch | - | Normally set at OFF. Use only when background noise is excessive. |

NOTE - The control settings listed above are those necessary for reception using automatic volume control and meter tuning. Should the operator wish to use manual control of the receiver's sensitivity set the A.V.C. switch at OFF and adjust the R.F. GAIN control for maximum required sensitivity. The tuning meter will not function when manual control of the receiver's sensitivity is employed.

b. F.M. (Frequency Modulation) Reception. - To receive a frequency modulated signal, set the panel controls as follows:

- | | | |
|-------------------|---|--|
| POWER switch | - | Set at ON when operating receiver on alternating current. To turn off receiver set switch at OFF. |
| | | CAUTION - Leave switch set at OFF when operating receiver from external batteries. |
| SEND/REC. switch | - | Set at REC. (Set at SEND to disable receiver when desired.) |
| A.M./F.M. switch | - | Set at F.M. |
| A.V.C. switch | - | Set at OFF. |
| R.F. GAIN control | - | Turn all the way to the right. (It is not necessary to actuate the switch.) |
| TUNING control | - | Set dial that is calibrated in megacycles to frequency of signal; adjust for zero setting of tuning meter. |
| ANTENNA control | - | Adjust for maximum signal level in headset or speaker if control is effective. (Adjustment is generally needed only on very weak signals.) |
| A.F. GAIN control | - | Adjust for desired signal level at headset or speaker. |
| TONE control | - | Set to please the listener. |
| A.N.L. switch | - | Set at OFF. (not used) |

3. STATION LOGGING

The frequency range shown on the main tuning dial is calibrated directly in megacycles. The outside scale, marked LOGGING SCALE, on the calibrated dial is used for logging purposes. The logging scale runs from 0 to 23. Each of the 23 divisions are further divided into 100 parts by the vernier dial scale, located just above the TUNING control. The vernier dial turns through 100 divisions as the calibrated dial moves through one division along the logging scale, hence, the log reading will be the calibrated dial reading followed by a decimal point and the vernier dial reading.

Example - Assume that the calibrated dial indicator rests between divisions 1 and 2 on the LOGGING SCALE and the vernier dial reads 60. Our log reading will then be 1.60. To retune the receiver to this setting again simply set the receiver's TUNING control so that the logging scale index falls between divisions 1 and 2 and the vernier dial indicates 60.

SECTION IV

FUNCTIONING OF PARTS

1. GENERAL

Figure 4-1. shows, in very simple block form, the plan of the circuit of the Model S-37 receiver. Note that the circuit is that of the conventional superheterodyne receiver up to the second-i-f amplifier stage. The output of the 2nd i-f amplifier is fed to two channels, namely, the F-M signal channel and the A-M signal channel. The F-M channel consists of the f-m limiter and discriminator and the A-M channel consists of an additional i-f amplifier stage and second detector stage. The demodulated signal from both channels then feeds the same audio amplifier being selected by the AM/FM switch.

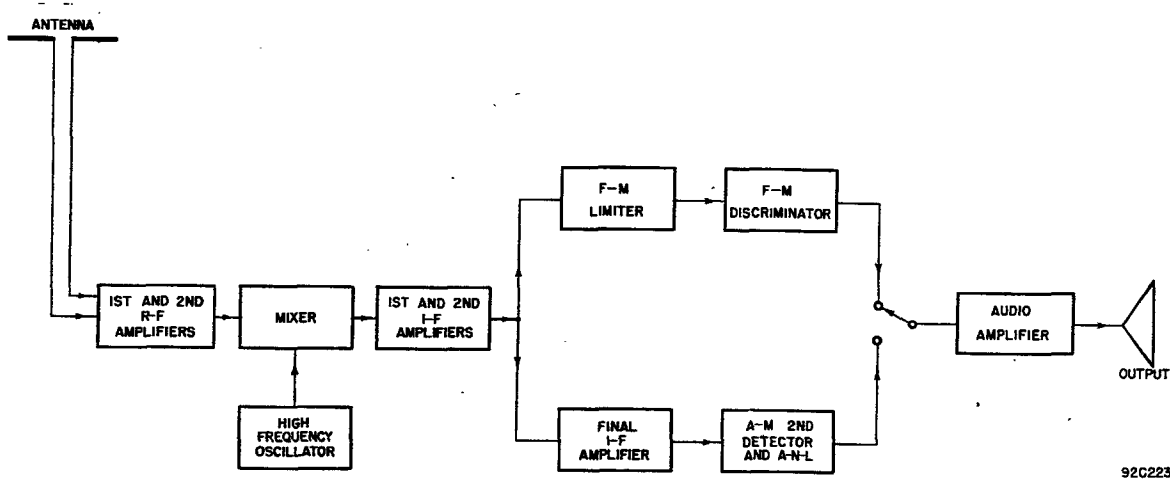

Fig. 4-1. Radio Receiver Model S-37, block diagram

2. DETAILED FUNCTIONING BY STAGES. (Refer to Fig. 7-7.)

a. R-F Amplifier. - The two r-f amplifier stages employ type 954 acorn pentode tubes in a conventional two stage amplifier circuit. Signals present at the antenna are fed to the primary of transformer T-1 through terminals A₁ and A₂ of antenna terminal strip TS-1. The secondary is tuned by the ganged tuning capacitor section C-1A and trimmer C-2. Trimmer capacitor C-2 is controlled from the front panel by the control marked ANTENNA to provide accurate alignment of the r-f stage with varying antenna load impedances. R-F signals selected by the parallel resonant circuit are applied to the grid of tube V-1 and appear in greater amplitude across the primary of transformer T-2. Parasitic resistor R-1 prevents unwanted oscillations in this stage and tends to stabilize the amplifier. Resistor R-2 by-passed by capacitor C-3, provides self-bias for the stage. Resistors R-3 and R-4 and capacitors C-4 and C-5 act as decoupling networks for the screen and plate circuit of tube V-1. The signal across the primary of transformer T-2 is coupled to the grid of tube V-2 inductively by transformer T-2 and capacitively by capacitor C-6. Capacitor C-6 provides a small amount of coupling to improve response at the high-frequency end of the band, thus equalizing the r-f signal amplitude over the tunable frequency range. The secondary of transformer T-2 is tuned by section C-1B of the ganged tuning capacitor and trimmer C-7. R-F signals applied to the grid of tube V-2 by the secondary winding of transformer T-2, appear at the primary of transformer T-3 in greater amplitude as a result of the amplifying action of tube V-2. Resistor R-5 by-passed by capacitor C-8 provides self-bias for the stage. Resistors R-6 and R-7 and capacitors C-9 and C-11 act as decoupling networks for the screen and plate circuit of tube V-2. The signal developed at the primary winding of transformer T-3 then feeds the mixer stage of the receiver.

b. Mixer. - The mixer stage employs a type 954 acorn pentode in a cathode coupled mixer circuit. The signal across the primary of transformer T-3 is coupled to the grid of tube V-3 inductively by transformer T-3 and capacitively by capacitor C-10. Capacitor C-10 provides a small amount of coupling to improve response at the high-frequency end of the band, thus equalizing the r-f signal amplitude over the tunable frequency range. The secondary of transformer T-3 is tuned by section T-10 of the ganged tuning capacitor and trimmer C-12. R-F signals selected by the parallel resonant circuit are applied to the grid of the mixer tube V-3. A signal from the local oscillator 16 megacycles lower in frequency than the receiver tuning frequency, is fed to the mixer tube through the cathode and provides the difference frequency of 16 mc. for the i-f stages.

c. Oscillator. - The oscillator circuit consists of a type 955 acorn triode in a tuned-plate untuned-grid type of oscillator circuit. The frequency of oscillation is determined by a resonant circuit which consists of the secondary of transformer T-4 and section C-1D of the main tuning gang connected in parallel. The r-f energy is fed from the plate of tube V-14 to the tuned circuit by the d-c blocking capacitor C-71. The decoupling network in the plate circuit of the oscillator tube consists of R-59, L-1, C-72, and R-60. Resistor R-62 and R-57 by-passed by capacitor C-68 are connected in series with the feedback winding of transformer T-4 to provide equal oscillator voltage to the mixer stage over the entire tuning range. The mixer voltage is further compensated by the network R-58 and C-70, connected in series with the winding feeding the cathode of the mixer tube.

d. First and 2nd I-F Amplifier. - The 1st and 2nd i-f amplifier stages employ type 6AC7 and 6AB7 pentodes respectively. The i-f amplifier coupling transformers T-5, T-6 and T-7 for these two stages are tuned to 16 mc. by adjusting the powdered iron core slugs in both primary and secondary windings. Each stage is neutralized by capacitors C-18 for tube V-4 and C-26 for tube V-5, to provide stable amplification at this relatively high intermediate frequency. The gain of the 1st and 2nd i-f amplifier stages is varied by the R.F. GAIN control (R-16), connected in series with the cathodes of both tubes, to provide sensitivity control for the receiver instead of the usual practice of varying the gain of the r-f amplifier stages. This method of control permits the r-f amplifier stages to operate at maximum gain, thereby providing a high signal to noise ratio at all sensitivity settings. The a-v-c grid voltage is applied to this section of the receiver through the decoupling networks C-17, R-12, R-13, C-74, and R-19, R-20 and C-25. The a-v-c voltage is supplied by the 2nd detector during a-m reception and a small amount of voltage is also supplied, for a similar purpose, from the limiter tube (V-8) during f-m reception.

e. Final I-F Amplifier. - The last i-f amplifier, used for a-m reception, employs a type 6SK7 pentode connected in a conventional circuit. The stage is coupled by transformers T-7 and T-8 which are tuned by adjustable iron core slugs. Resistor R-27 by-passed by capacitor C-32 provides self-bias for the stage. The gain of this stage is not varied as was the case for the 1st and 2nd i-f amplifier stages. The amplified voltage developed across the secondary of transformer T-8 is then fed to the 2nd detector for demodulation of a-m signals.

f. A-M 2nd. Detector and A-N-L. - Both the second detector and automatic noise limiter stages employ a single type 6H6 duo-diode. One diode section of tube V-7 serves as detector for amplitude modulated signals by rectifying the modulated carrier. The r-f filter for this type of detection consists of resistor R-31, and capacitors C-37 and C-38 connected in a pi-section. Automatic volume control voltage and audio frequency voltage is obtained from the load and voltage divider resistors R-33, R-34, R-35. Resistor R-36 serves as a-v-c decoupling. The remaining diode section of tube V-7 serves as automatic noise limiter as follows: Capacitor C-39 becomes charged by the rectified carrier voltage and the time constant of this capacitor and the filter network associated with it is such, that the audio frequency voltage variations do not alter this charge. During a severe noise pulse, however, the cathode of the diode plate connected to capacitor C-39 becomes more negative than the charge held by C-39, hence, current flows shorting the audio voltage to ground through capacitor C-39 until the cathode voltage of the a-n-l diode again reaches a less negative potential than its plate and capacitor C-39 acquires its normal charge again. By shorting the audio voltage to ground during a noise pulse, the a-n-l circuit prevents the objectional noise pulses from reaching the audio amplifier stages.

g. F-M Limiter and Discriminator. - The frequency modulation detector consists of a limiter stage and a discriminator stage. The type 6AC7 limiter tube (V-8) is fed by the second i-f transformer secondary winding along with the third i-f amplifier tube V-6 for a-m reception. The limiter stage operates as a saturated amplifier in which the output remains constant over a large range of input voltage levels, thus eliminating variations in the amplitude of the carrier signal to be demodulated by the discriminator. When operating as an f-m receiver, automatic volume control action is obtained by applying a part of the voltage developed across resistor R-41 in the grid return of the limiter tube (V-8), to the control grids of the 1st and 2nd i-f amplifier tubes (V-4 and V-5) through section SW-4A of the F.M./A.M. switch. The constant level signal out of the limiter tube (V-8) is fed to the discriminator tube (V-9) through the discriminator transformer (T-14) and coupling capacitor C-40. The discriminator circuit, consisting of transformer T-9, tube V-9 and load resistors R-45 and R-46, converts the frequency variations of the f-m signal into amplitude variations or the audio signals. The de-emphasis network, consisting of resistor R-47 and capacitor C-47, attenuates the high frequency end of the audio range since these frequencies are emphasized at the f-m transmitter. From the de-emphasis network the audio signal is fed to the A.F. GAIN control (R-48) in the same way as the signal from the amplitude modulation detector tube (V-7).

h. Audio Amplifier. - The audio amplifier consists of a conventional high-mu triode class A voltage amplifier driving a single beam power amplifier also operating class A.

(1) **Voltage Amplifier.** - The voltage amplifier stage employs a type 6SL7GT twin-triode tube with its elements connected in parallel. Self bias voltage obtained from resistor R-49 by-passed by capacitor C-49 provides grid bias voltage for class A operation. The stage operates into its plate load resistor R-50 from which grid voltage for the beam power stage is obtained as well as audio voltage for headset operation. Capacitor C-52 isolates the d-c plate voltage from the headset and beam power amplifier grid.

(2) **Power Amplifier.** - The power amplifier employs a type 6V6GT/G beam-power amplifier in a resistance capacity coupled single ended class A amplifier circuit. Grid bias is obtained from cathode resistor R-53 which is by-passed by capacitor C-50. The output of tube V-11 is coupled to the speaker load by transformer T-10 which provides proper matching for 5000 and 500 ohm loads. When the headset is plugged into the circuit, resistor R-54 is automatically connected across the 5000 - ohm winding to maintain proper load impedance for the beam power stage. If a speaker is connected to the 5000 ohm outlet, it will be automatically disabled when the headset is plugged in. The frequency response of the power amplifier stage is controlled by variable resistor R-52 and capacitor C-51 connected in series from the grid of tube V-11 to ground. As the resistance of R-52 is lowered, the higher audio frequencies are attenuated producing a bass boost effect in the output.

i. Tuning Meter. - The tuning meter is switched between two circuits depending upon the type of reception:

(1) **A-M Reception.** - When metering reception of a-m signals the tuning meter measures the plate current of the 2nd i-f amplifier stage which varies as the strength of the signal carrier. Resistor R-55 sets the zero (no signal) position by adjusting the plate current of tube V-5. A carrier then drives the plate current of tube V-5 to a lower value depending upon the signal strength. The screen grid voltage of tube V-5 is regulated by the voltage regulator tube to provide accurate control over the plate current.

(2) **F-M Reception.** - When metering reception of f-m signals the tuning meter measures the unbalanced current in resistors R-45 and R-46 obtained when the receiver is tuned to one side of the f-m carrier. When the receiver is tuned to the exact center of the f-m carrier the meter rests at zero indicating that the currents in the discriminator load resistors are equal. Resistor R-43 functions to limit the maximum current in the meter circuit to a safe value.

j. Power Supply. - The receiver has provisions for operation from either an a-c or d-c source.

(1) A-C Operation. - The internal power supply provides for operation from 115 or 230-volt a-c mains. The a-c current is fed through a line filter which is a low pass pi-section network connected in each side of the line. The networks consist of inductances L-2 and L-3 and capacitors C-64, C-65, C-66 and C-67. The line filter attenuates all the objectionable noise components coming into the receiver circuit through the a-c power source. The filament and high voltage supply transformers are separate units, each provided with a tapped primary for 115- or 230-volts operation. The taps must be wired accordingly each time the line potential is changed. A type 5U4G (tube V-13) full-wave rectifier is employed in a conventional rectifier circuit. The high voltage from this rectifier is fed to the filter network through the "Shorting Plug" on the rear apron of the receiver chassis as is the filament current for the heaters of the tubes. The SEND-REC. switch is connected in series with the center tap of the high voltage secondary of transformer T-12 and ground to break the high voltage circuit in order to disable the receiver and yet keep the tube heaters hot ready for instant use. The filter circuit consists of two low pass pi-section networks made up of inductances L-4 and L-5 and capacitors C-58, C-57, C-56, C-55 and C-54. In order to provide a constant plate voltage to the oscillator, mixer and screen of the second i-f stages a voltage regulator tube type 0D3/VR-150 is used. The voltage supplied to the screen of tube V-5 is regulated to provide accurate current control for the tuning meter connected in the plate circuit of this tube.

(2) D-C Operation. - External storage battery and "B" batteries or storage battery and vibrator type supply provide for d-c operation. When operating from an external d-c supply the "Shorting Plug" on the rear apron of the receiver chassis is removed and a similar plug is wired to supply filament and plate current to the receiver circuits. The "B" voltage is supplied to the input side of the filter section used for a-c operation there by insuring adequate filtering for vibrator type supplies when used.

SECTION V

MAINTENANCE

CAUTION - Voltages at various points in this equipment are of sufficiently high potential to produce a severe shock. Locate the high potential points on the VOLTAGE-RESISTANCE DIAGRAM before attempting to service circuits that are "hot". IT'S A GOOD RULE TO DISCONNECT THE POWER SOURCE BEFORE MAKING ADJUSTMENTS WHEN POSSIBLE. BE CAREFUL.

1. PREVENTIVE MAINTENANCE

All components of the receiver should be given a thorough inspection at regular intervals. Keep the components clean and dry. Moisture, even in a completely tropicalized set may cause serious deterioration and produce general unsatisfactory operation. Dust and dirt materially effect both electrical and mechanical operation. Keep the various parts clean especially the tuning capacitor and associated gear drive. Dust should be blown out with dry air or brushed out carefully. Do not oil the gear teeth or the condenser wipers as noisy reception will result from intermittent electrical contact at these points. Noisy reception may also be caused by dirty condenser wipers, faulty gain controls, and switches, frayed cable connections, faulty tubes, etc. in the installation. Check accessible connections, switch contacts, etc. regularly making sure that all are clean and tight and the tubes and cable connectors are held securely in their sockets.

2. REPLACING TUBES, LAMPS, AND FUSES

a. **Replacing Tubes.** - All tubes with the exception of the four acorn types are accessible at the top of the chassis through the hinged cover of the cabinet. The four acorn type tubes are made accessible by removing the top cover of the r-f section which is held down by thumb screws. The acorn tubes should be inserted with the short end of the body in the socket. Acorn tubes are more fragile than the rest and should be handled accordingly. If the grid and plate clips on the connections to these tubes become loose replace or bend to fit. DO NOT ATTEMPT TO SOLDER DIRECTLY TO THE TUBE PIN as the heat generated by the soldering iron will crack the glass envelope. When replacing tubes, check the tube type carefully and replace with the correct tube type. Refer to the top view of the chassis to determine the location of the tubes and to the PARTS LIST for the type number and description of each.

b. **Replacing Lamps.** - The receiver employs two lamps with bayonet type sockets to illuminate the vernier dial and the tuning meter. The lamps illuminating the vernier dial scale and tuning meter are to be replaced by a 6/8-volt, 150 ma. (Brown bead) G.E. 47 or equivalent. The color code referred to, is the color of the glass bead above the glass stem inside the envelope of the lamp. The lamp illuminating the meter scale is removed by pulling the lamp socket from the rubber grommet in the meter case. When reinserting the lamp, do not push the socket assembly too far into the meter case as a hot spot of light will appear on the meter scale instead of even area of illumination.

c. **Replacing Fuses.** - Two fuses are used, one in each side of the a-c line. The fuse holders are located on the rear apron of the chassis and require a screw driver to remove the fuse. Replace burned out fuses with 3-ampere 250-volt, Little Fuse type 3AG or equivalent.

CAUTION - The fuses protect your equipment, don't take chances using fuses rated for a heavier current drain than 3 amperes.

3. PERIODIC ADJUSTMENTS

a. Tuning Meter Adjustment. -

- (1) The tuning meter zero setting control is located behind its front panel button type cover marked S-METER ADJ. Remove the button with a knife or screw driver blade.
- (2) Disconnect the antenna and connect a jumper across terminals A₁, A₂, and GND.
- (3) Set the front panel controls for amplitude modulation reception as follows:
 - (a) Set A.M./F.M. switch at A.M.
 - (b) Set A.V.C. switch at ON.
 - (c) Turn R.F. GAIN control to right until the switch on the control clicks.
 - (d) Set A.F. GAIN control for minimum gain. (All the way to the left).
 - (e) Set A.N.L. switch at OFF.
 - (f) Set SEND-REC. switch at REC.
- (4) With a screw driver set the S-METER ADJ. control for the zero reading on the S-meter scale of the tuning meter.
- (5) Remove the antenna terminal jumper and replace antenna leads and meter adjustment cover button, the adjustment is completed.

b. Receiver Alignment. - The receiver has been carefully aligned at the factory and should not require realignment until the receiver requires new tubes in the r-f and i-f stages or shows signs of loss of sensitivity, off frequency calibration or requires service work on one or more of its r-f and i-f stages. Alignment should not be attempted by inexperienced personnel as maximum performance is obtained only by careful and intelligent alignment.

(1) Aligning Tools. -

- (a) Signal generator capable of providing a 400-cycle modulated signal at 16 mc. and 130 to 210 mc. range. Recommended generators are the Ferris Instrument Corp. Model 18D or 18FS and the Measurements Corp. Model 75.
- (b) A 50-ohm non-inductive dummy antenna resistor.
- (c) Non-metallic screw driver. A bakelite screw driver with a short metal blade is very good.
- (d) Audio output meter capable of handling 5 watts of audio power for either 500 or 5000-ohm loads.

(2) I-F Amplifier Alignment. -

- (a) Disconnect the grid lead of the type 954 mixer tube (V-3) and connect the signal generator to the grid of the mixer tube, using a small clip or flexible piece of wire to make the connection. Connect the ground wire of the generator to the receiver chassis.

CAUTION - Do not attempt to solder to the tube terminal as the heat of the soldering iron is certain to crack the glass envelope.

- (b) Connect the output meter across the speaker terminals. Set the range of the output meter for its highest range to prevent overloading the meter accidentally.

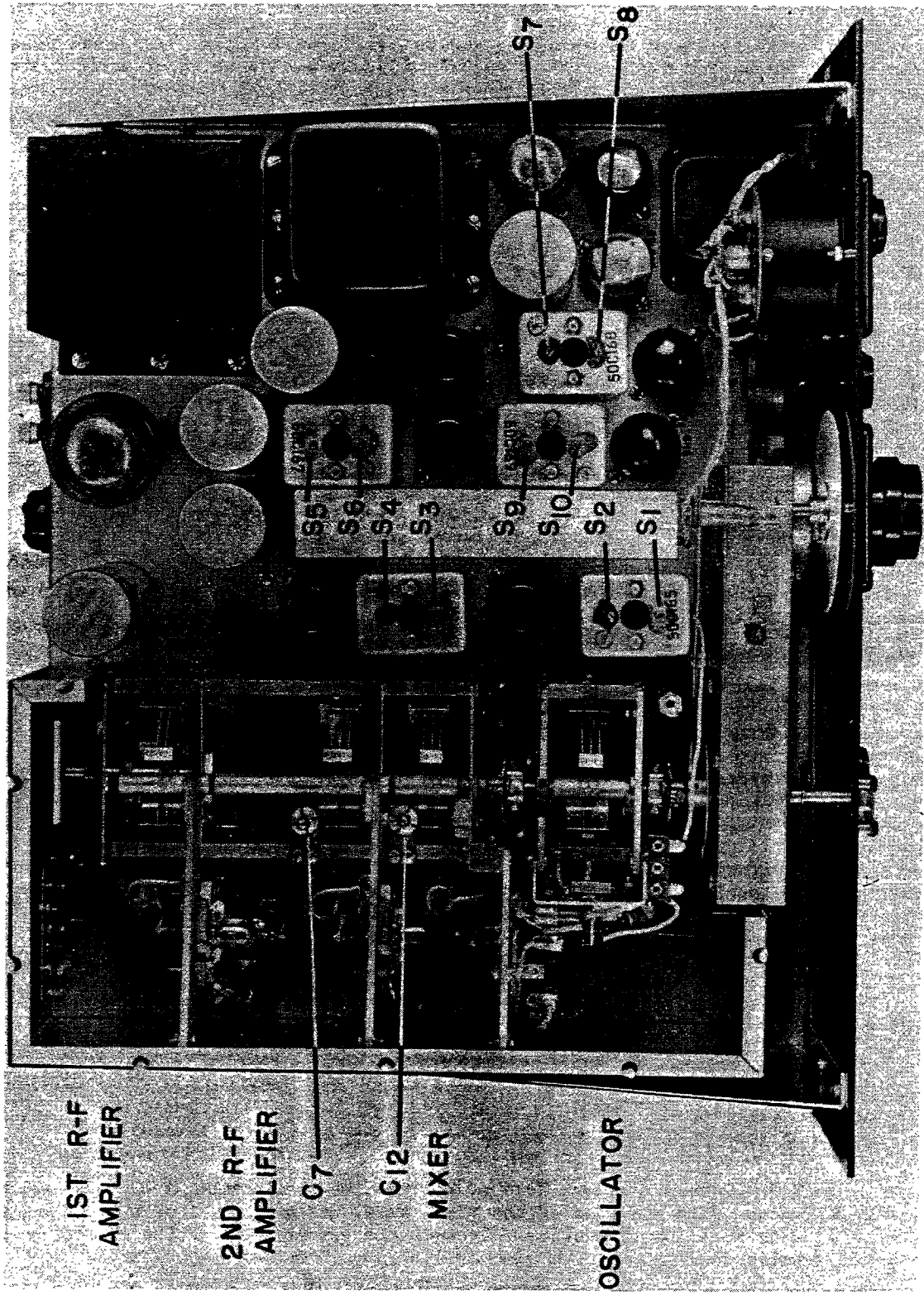

Figure 5-1. Radio Receiver Model S-37, top view showing alignment points.

(c) Let the receiver warm up for approximately half an hour then set the receiver controls as follows:

R.F. GAIN control at maximum gain.

A.F. GAIN control at maximum gain permitted by local noise level. Work in a shielded room if possible.

A.M./F.M. switch at A.M.

A.V.C. switch at OFF.

A.N.L. switch at OFF.

SEND/REC. switch at REC.

(d) Set the signal generator frequency at 16 megacycles and turn on the 400-cycle modulation.

(e) Adjust i-f transformers T-5, T-6, T-7, and T-8 for maximum response by tuning for maximum signal level at the output meter using just enough signal generator output to provide a good resonant swing on the output meter. The signal level at the generator should run not more than 70 microvolts for a 500 milliwatt audio output level. Repeat the alignment procedure until assured of accurate alignment. Refer to figure 5-1 for the location of i-f transformer adjustment screws S_1 through S_8 inclusive on i-f transformers T-5, T-6, T-7, and T-8.

(f) Disconnect the filament lead of the 1st i-f amplifier tube (V-4) at pin #2 of the d-c power input socket (S0-1) on the rear apron of the chassis. Refer to Fig. 7-7. Allow the filament of tube V-4 about one minute to cool off before proceeding.

(g) Increase the output of the signal generator until a readable signal level is indicated by the output meter and adjust neutralizing capacitor C-18 for minimum output. While adjusting capacitor C-18, adjust slug adjustment S_3 on transformer T-6 for maximum output to compensate for detuning caused by adjusting C-18. Repeat the procedure until satisfied that the best possible settings have been obtained.

(h) Reconnect the filament lead of tube V-4 and disconnect the filament lead of the 2nd i-f amplifier tube V-5 at the d-c power input socket. Allow a minute for the tube to cool as before.

(i) Adjust neutralizing capacitor C-26 and slug adjustment S_5 on transformer T-7 for their optimum settings as for the 1st i-f amplifier stage. Reconnect the filament lead again before proceeding.

(j) Detune transformers T-6 (Slugs S_3 and S_4) and T-8 (Slugs S_7 and S_8) until a fairly high signal generator output is required to produce a readable output meter reading. First adjust transformers T-5 and T-7 for maximum output, then adjust transformer T-8 and finally transformer T-6. Do not readjust transformers T-5 and T-7 when adjusting T-8 and T-6. Reduce the signal generator output as required while bringing these last two i-f transformers into alignment.

(3) Discriminator Transformer Alignment. -

(a) Set the A.M./F.M. switch at F.M.

(b) Leave the signal generator set at 16 mc. with 400 cycle modulation.

(c) Adjust the secondary slug (S_{10}) of the discriminator transformer (T_9) for zero signal level at the output meter. Note that this adjustment is critical, therefore turn the screw slowly.

(d) Detune the signal generator from the 16 mc i-f frequency until a readable indication is obtained at the output meter and adjust the primary slug (S-9) for maximum output meter reading.

(e) Balance up the discriminator stage as follows:

1. Detune the signal generator to either side of the 16 mc resonant point and note the maximum output meter readings obtained. If they are equal, the discriminator stage is functioning properly, if not, proceed with the balancing adjustment that follows.

2. To balance up an unbalanced condition, tune the signal generator to the resonant point of the weaker peak and tune the primary slug (S_9) until the output rises about one-half the difference of the unbalanced readings obtained in step 1. Recheck for balance and repeat the balancing procedure if necessary.

NOTE - If a balance cannot be obtained by adjusting the primary slug (S_9), the discriminator's secondary slug (S_{10}) has been misadjusted slightly and will require a very slight readjustment in either direction. The direction of adjustment that will cause the off-tune peaks to assume the same values is the correct one. Note that the quality of the f-m signal will depend materially upon the degree of balance obtained, hence, a little care will be well repaid in performance.

(f) Disconnect the signal generator and reconnect the grid lead to the mixer tube, the alignment of the i-f amplifier stages is completed.

(4) R-F Amplifier Alignment. -

(a) Connect the signal generator to the "A₁" antenna terminal through a 50-ohm resistor and connect the ground wire of the signal generator to terminal "A₂". Disconnect the jumper wire between "A₂" and "GND" as the generator should not be grounded to the receiver's chassis for the following adjustments.

(b) Set the receiver controls as for i-f amplifier alignment. Refer to paragraph 3. b. (2) (c) this section.

(c) Set the signal generator at 210 mc. and turn on 400 cycle modulation.

Note - if your signal generator will not reach 210 mc. use the harmonic of the generator signal.

(d) Set the receiver's TUNING dial at 210 mc. and set the ANTENNA control for maximum output, then adjust capacitors C-7 and C-12 for maximum output while "rocking" the TUNING dial control back and forth across the generator signal. Use just enough signal generator output to provide a readable resonance point at the output meter.

NOTE - Should it be necessary to adjust the frequency of the oscillator to make the receiver's dial reading fall on 210 mc exactly, loosen and shift the heavy wire primary winding (oscillator transformer T-4 primary) nearest to the front panel and the heavy wire coupling loop on the opposite side of the heavy tubing secondary winding. Take care that the coupling between the primary winding and the secondary is not reduced below that necessary to maintain adequate feed back for the oscillator over the entire band. Having obtained proper adjustment recement the winding in place with Amphenol "912" or an equivalent low loss cement. After adjusting the oscillator frequency realign capacitors C-7 and C-12 as described above.

(e) Set the signal generator at 130 mc, tune in the signal on the receiver and check to see that the receiver's main tuning dial reads 130 mc. If not, the secondary (heavy tubular winding) inductance of transformers T-1, T-2, T-3, and T-4 must be adjusted by loosening the clamps and set screws which hold them in place and sliding the transformers back and forth. Tighten all set screws after adjustment.

NOTE - If it is necessary to adjust the inductance of the windings at 130 mc. the adjustments in paragraph (d) must be repeated at 210 mc to bring the high frequency end of the range into alignment again.

(f) Repeat steps (d) and (e) until the receiver alignment and calibration are satisfactory then make the following check to see that the oscillator frequency falls below the signal frequency as it should. For example: Set the receiver dial at 165 mc., turn up the signal generator output to about 5000 times normal, and set the signal generator frequency at twice the i-f frequency lower than 165 mc. or 133 mc. An image signal should be heard. If not, tune the signal generator to twice the i-f frequency higher than the signal frequency or 197 mc. and look for the image there. If the image shows up at the 197 mc. the receiver's oscillator is operating above the signal frequency and must be readjusted so that it falls below the signal frequency. Due to the construction of this receiver it is considered impossible to adjust the oscillator frequency so that it will fall above the signal frequency, however, it is always well to check for the image after making any extensive alignment adjustments.

(g) When completely aligned the overall receiver sensitivity will usually run between 10 to 15 microvolts for 500 milliwatts audio output. If your receiver falls reasonably close to this sensitivity, consider your alignment adjustments satisfactory.

4. LOCATING FAULTS WITH A VOLT-OHM METER

a. Voltage Chart. - Refer to Fig. 5-2. for the tube socket terminal voltages. Voltages shown are those between the terminal and ground (chassis) unless otherwise specified. To identify the tube socket connections, refer to Fig. 7-6. The readings were taken with an RCA Volt Ohmyst Junior analyzer using 20,000 ohm per volt sensitivity. To prepare the receiver for measurement, disconnect the antenna, connect a jumper between the antenna terminals A₁, A₂, and GND., disconnect the speaker and replace with a 5000-ohm 10-watt resistor across the 5000-ohm output terminals or a 500-ohm 10-watt resistor across the 500-ohm terminals, and set the controls as follows:

POWER, A.V.C. and A.N.L. switches at ON.

SEND/REC. switch at REC.

A.M./F.M. switch at A.M.

R.F. GAIN and A.F. GAIN controls at maximum gain position.

ANTENNA TUNING and TONE controls do not effect readings.

b. Resistance Chart. - Refer to Fig. 5-3. for the tube socket terminal to ground (chassis) resistance measurements. To identify tube socket connections, refer to Fig. 7-6. The readings were taken with an RCA Volt Ohmyst Junior analyzer. To prepare the receiver for measurement, disconnect the a-c line cord and set the controls as follows:

POWER, A.V.C. and A.N.L. switches at ON.

SEND/REC. switch at REC.

A.M./F.M. switch at A.M.

R.F. GAIN and A.F. GAIN controls at maximum gain position.

TONE control at maximum clock-wise position.

ANTENNA and TUNING controls do not effect readings.

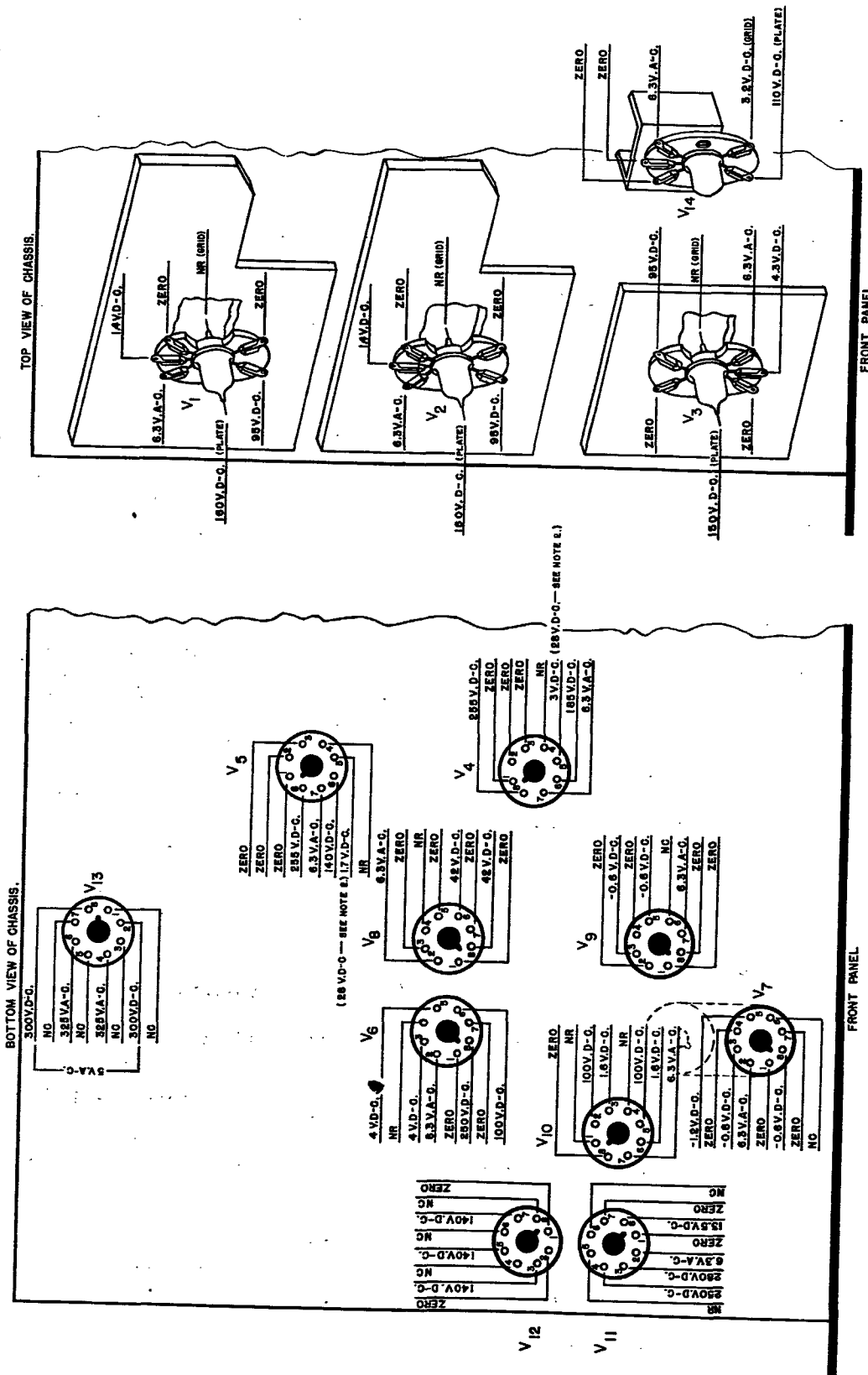

- NOTE: 1. ALL READINGS ARE FOR 117 VOLT A-C LINE VOLTAGE.
 2. VOLTAGE READING WITH "R-F GAIN" AT MINIMUM GAIN POSITION.
 3. NC = NO CONNECTION.
 4. NR = NOT READABLE WITH A 20,000 OHM/VOLT METER.

92D236

Figure 5-2. Radio Receiver Model S-37, voltage chart.

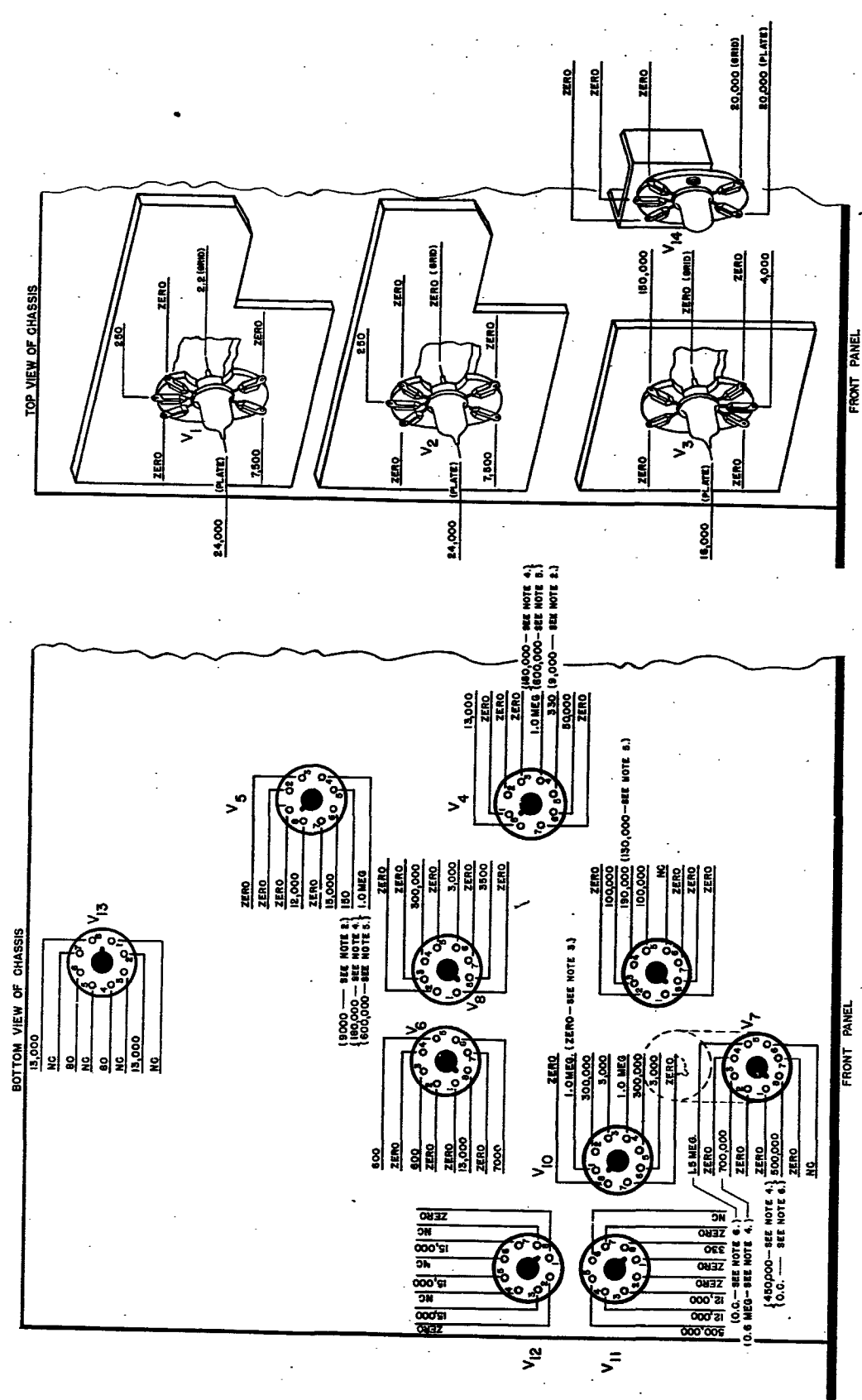

NOTE:

1. CIRCUIT RESISTANCES LESS THAN ONE OHM ARE SHOWN AS ZERO.
2. RESISTANCE READING WITH "R.F. GAIN" CONTROL SET AT "MINIMUM" POSITION.
3. RESISTANCE READING WITH "A.F. GAIN" CONTROL SET AT "MINIMUM GAIN" POSITION.
4. RESISTANCE READING WITH "A.V.C." SWITCH SET AT "OFF" "P.M."
5. RESISTANCE READING WITH "A.M./F.M." SWITCH SET AT "P.M."
6. RESISTANCE READING WITH "A.M.L." SWITCH SET AT "OFF"
7. NO = NO CONNECTION.
8. O.C. = OPEN CIRCUIT.

Figure 5-3. Radio Receiver Model S-37, resistance chart.

CAUTION - The receiver's line cord, if operating from an a-c outlet, or the battery supply cord, if operating from a d-c supply, must be disconnected before making resistance measurements.

c. Checking Transformer and Inductor Windings With an Ohm-meter. -

NOTE - One terminal of each winding measured must be disconnected from the circuit to avoid measuring circuit resistances instead of winding resistance alone as indicated in the chart.

Circuit symbol	Name of part	Winding	Winding terminals	D-C resistance (ohms)
T-10	TRANSFORMER, audio.	Primary.	1 to 2	300
		5000-ohm secondary.	3 to 6	250
		500-ohm secondary.	3 to 5	22
T-11	TRANSFORMER, filament power.	115-volt primary.	± to 115 V.	12
		230-volt primary.	± to 230 V.	40
		6.3 ¹ / ₂ -volt secondary.	-	Less than one ohm.
		5.0-volt secondary.	-	Less than one ohm.
T-12	TRANSFORMER, plate power	115-volt primary.	± to 115 V.	7
		230-volt primary.	± to 230 V.	20
		¹ / ₂ secondary.	CT to 288 V.	75
		Secondary	288 V. to 288 V.	150
L-4	REACTOR, filter.	-	1 to 2	85
L-5	REACTOR, filter.	-	-	300

SECTION VI SUPPLEMENTARY DATA

1. FREQUENCY RANGE.

130 mc. - 210 mc. (Covered in one band)

2. POWER INPUT.

a. A-C Operation.

Line Voltage - 115 V. or 230 V.

Line current - 1.0 amp. at 115 V. or 0.5 amp. at 230 V.

b. D-C Operation.

Storage battery voltage - 6 V.

*Storage battery current drain - 3.6 amps. (Filament current only)

*B" battery or vibrator supply voltage - 270 V.

*B" battery or vibrator supply current drain - 125 ma.

* NOTE - When a vibrator supply operates from the storage battery the drain will run about 18-20 amperes.

3. AUDIO POWER OUTPUT.

Speaker operation - 2 watts with less than 5% distortion

Headset operation - High impedance.

4. SENSITIVITY.

At 130 mc. - 15 microvolts. (For 500 milliwatt audio output.)

At 200 mc. - 7 microvolts, (For 500 milliwatt audio output.)

5. SIGNAL TO NOISE RATIO.

Not less than 5 to 1 when measured with a 3.5 microvolt, 400-cycle 30% modulated signal.

6. AUDIO FIDELITY.

Audio response is flat within \pm 4 db. from 100 to 10,000 cycles per second.

7. IMAGE RATIO.

Not less than 60 db. between 130 mc. and 210 mc.

8. SELECTIVITY.

I-F selectivity measured at the grid of the mixer tube is not less than 140 kc. or more than 180 kc. AT 6 dB down from resonance. The receiver will be more selective when measured AT the antenna terminals.

9. OVERALL WEIGHT

Net 80 pounds.

10. OVERALL DIMENSIONS

Height 9-3/8 x Width 19-1/8 x Depth 16-1/4 (inches)

NOTE - Allow additional height of 11 inches to clear cover in top of cabinet.

SECTION VII
DRAWINGS

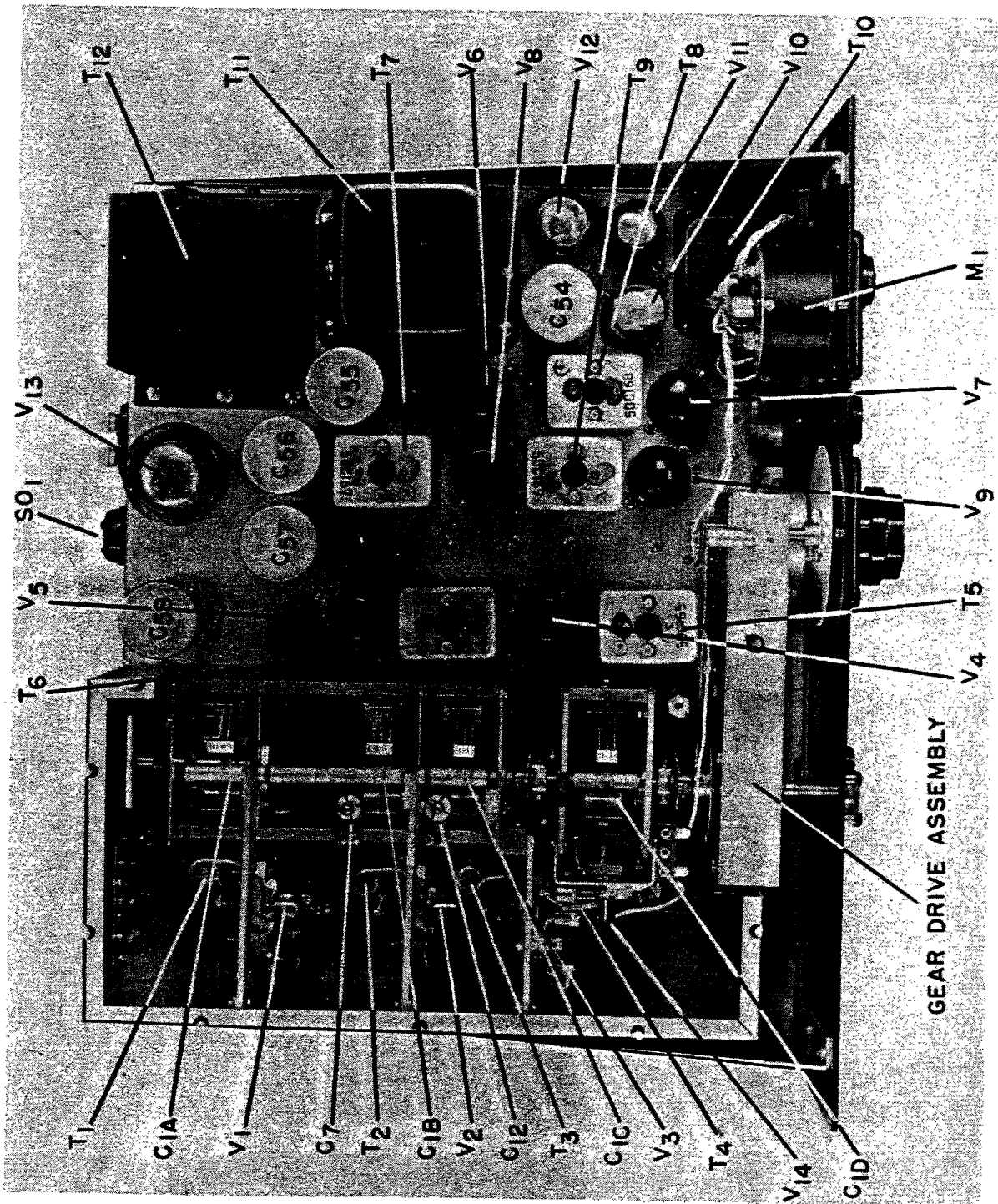

Figure 7-1. Radio Receiver Model S-37, top view.

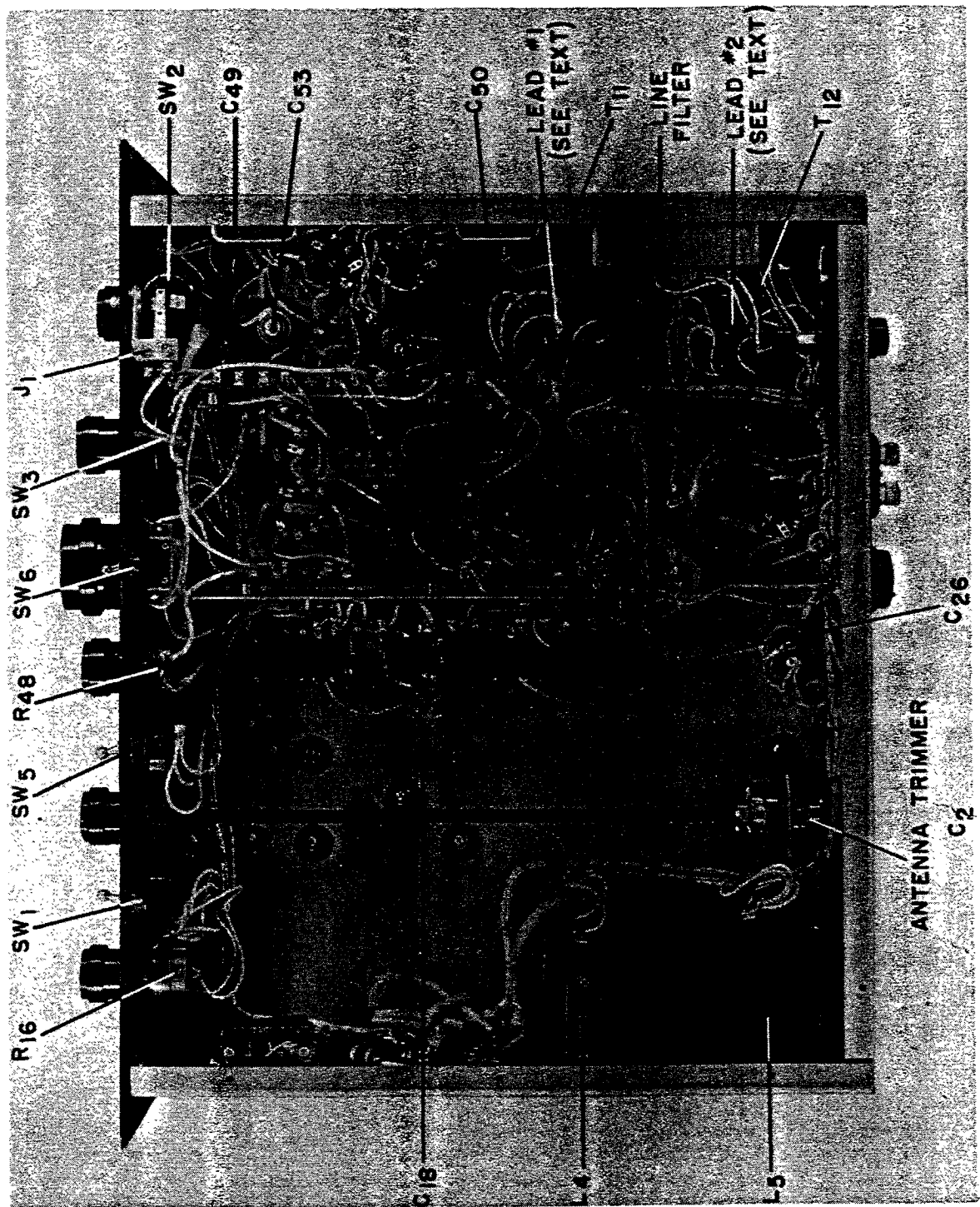

Figure 7-2. Radio Receiver Model S-37, bottom view.

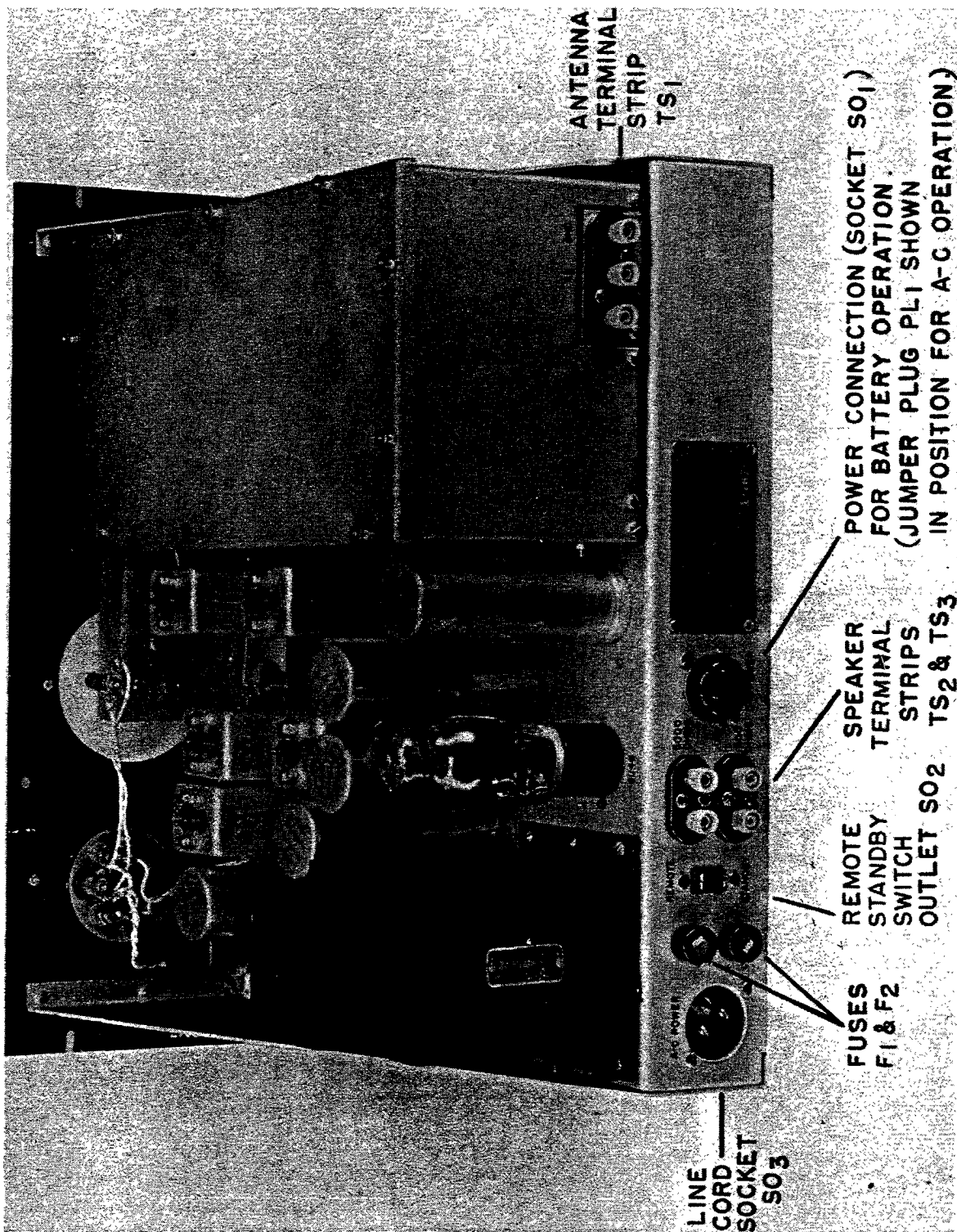

Figure 7-3. Radio Receiver Model S-37, rear view.

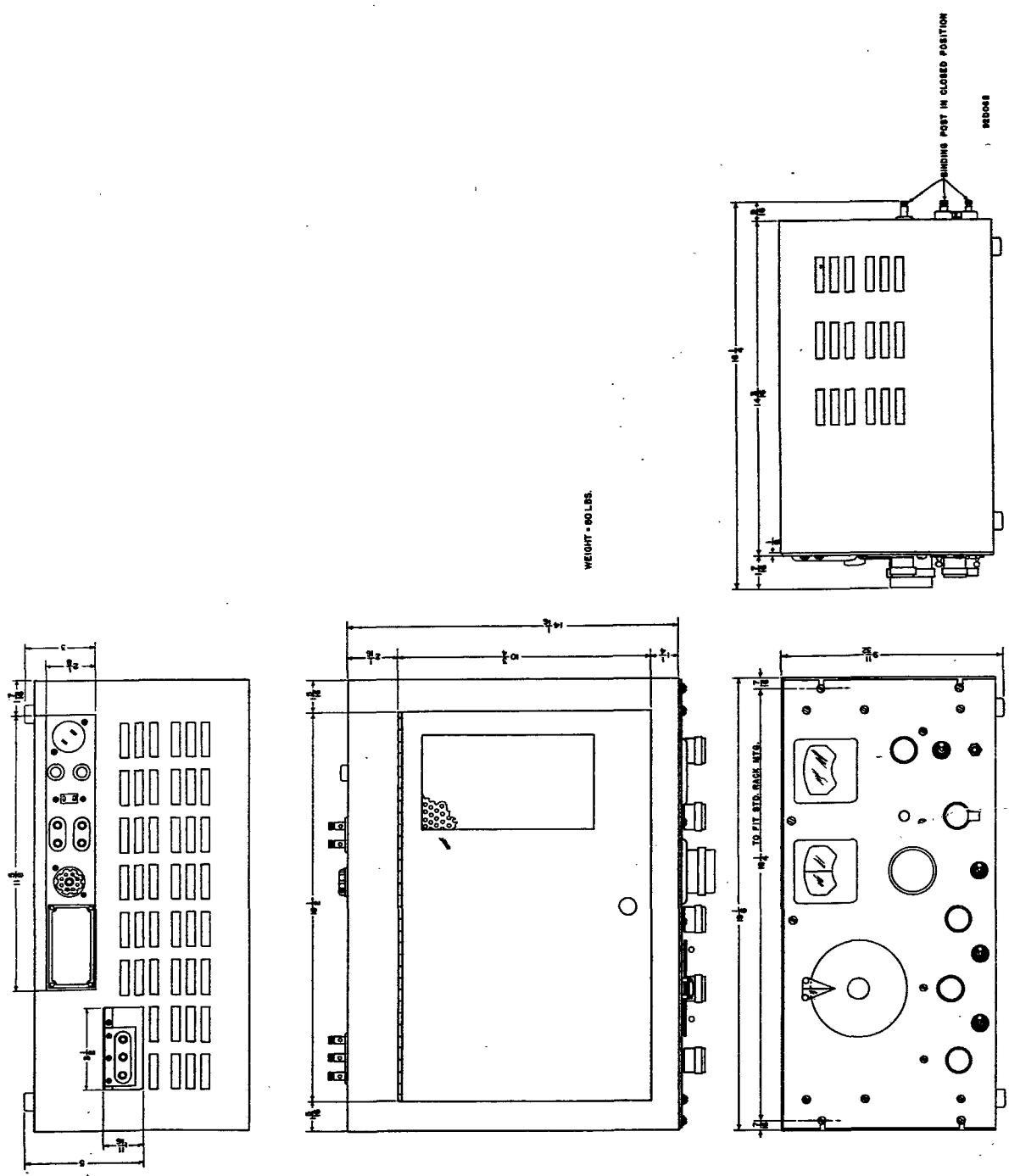
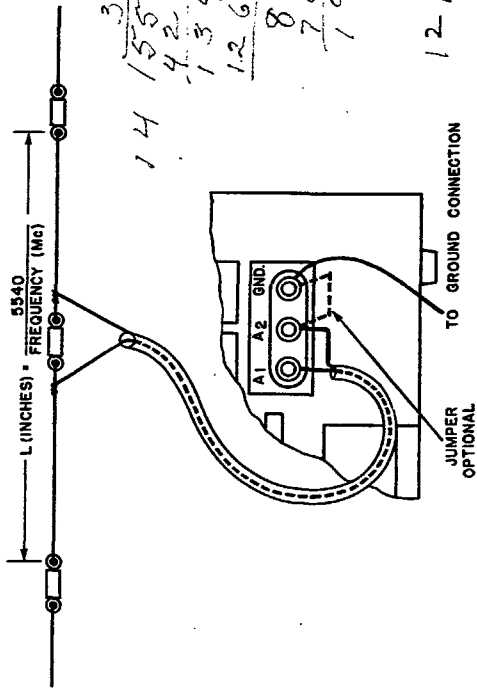

Figure 7-4. Radio Receiver Model S-37, outline dimensions.

DOUBLET ANTENNA INSTALLATION
USING CO-AXIAL LINE LEAD-IN



14
395.7
155400
42
1340
126
80
78
100

329.7
12395.70
35
24
117
108
90

SINGLE WIRE ANTENNA INSTALLATION

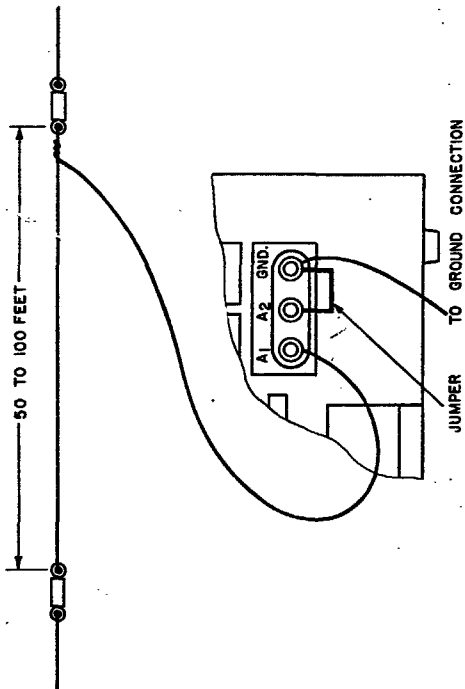

DOUBLET ANTENNA INSTALLATION
USING TWISTED PAIR LEAD-IN

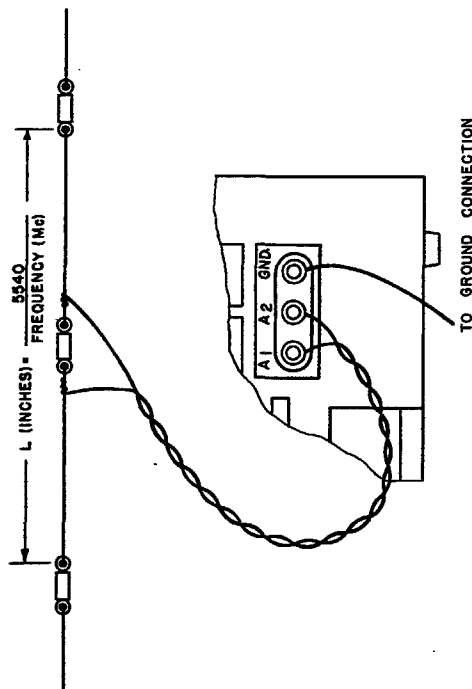

MULTIPLE DIPOLE ANTENNA
TOP VIEW

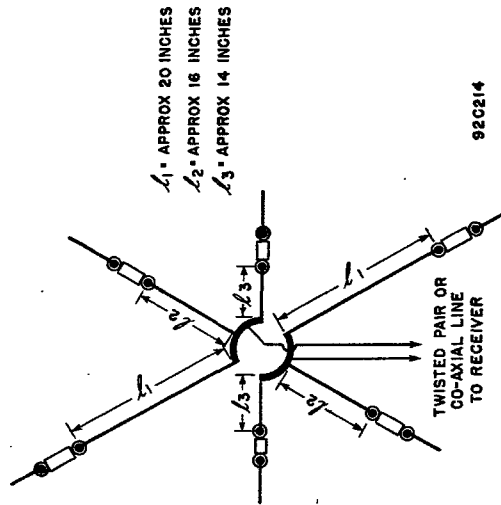

920214

Figure 7-5. Radio Receiver Model 8-37, recommended antenna installations.

ACORN TYPE TUBES

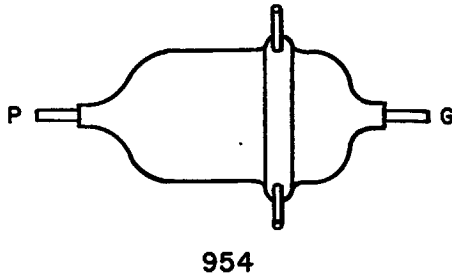

- 954**
- 1 HEATER
 - 2 SCREEN
 - 3 SUPPRESSOR
 - 4 HEATER
 - 5 CATHODE

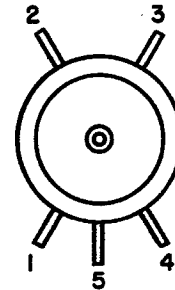

- 955**
- 1 HEATER
 - 2 PLATE
 - 3 GRID
 - 4 HEATER
 - 5 CATHODE

STANDARD TYPE TUBES

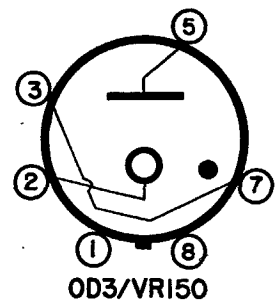
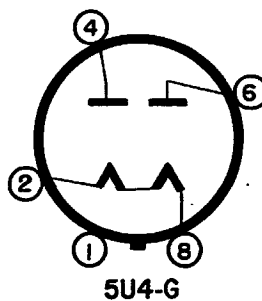
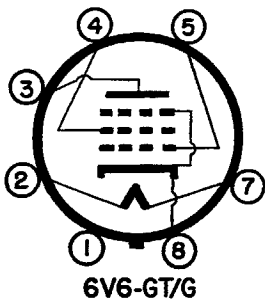
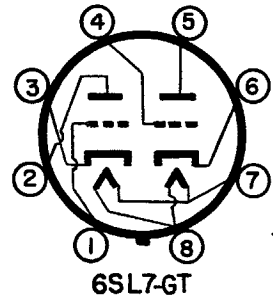
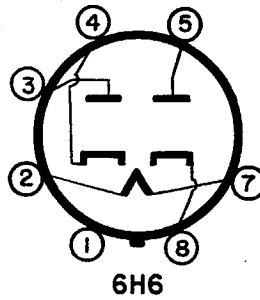
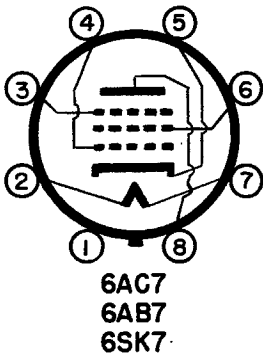

92B227

Figure 7-6. Radio Receiver Model S-37, tube socket connections.

SECTION VIII
PARTS LIST

MODEL S-37 PARTS LIST

Ref. Symbol	Name of Part and Description	Function	Mfr Code and Type No.	Hallicrafter's Part No.
<p>C_{1A} C_{1B} C_{1C}</p>	<p>Capacitor, variable: air dielectric; 4 sections, section 1 (C_{1A}), approx. 6 mmf min to 26 mmf max. sections 2 & 3 (C_{1B} and C_{1C}) capacity approx. 6 mmf min to 34 mmf max. section 4 (C₂) capacity; approx. 6 mmf min. to 10.5 mmf max; 6-$\frac{1}{8}$" lg excluding shaft, shaft $\frac{1}{2}$" lg x 0.376/0.373" diam. for sections 1, 2 and 3, shaft for section 4 is 21/32" lg x $\frac{1}{8}$" diam; section 1 has 4 plates, sections 2 & 3 have 5 plates each, section 4 has 6 plates, common stator plates for sections 1 and 4; X2B bakelite insulation; spade lug mtg bolts not supplied with unit; each section has rotor shaft insulated from other sections; section 4 is separate rotor assembly bolted to main unit so that the plates mesh with section 1 stator plates and has its own drive shaft assembly consisting of a 1 to 1 ratio brass and fibre gear drive assembly.</p>	<p>R-F amplifier tuning</p>	<p>OM Special</p>	<p>48C067</p>
<p>C_{1D}</p>	<p>Capacitor, variable, single section, effective capacity 28 mmf., air dielectric, unit is ganged to C₁.</p>	<p>Oscillator tuning</p>	<p>H Special</p>	<p>48B066</p>
<p>C₂</p>	<p>Section 4 of Hallicrafters variable capacitor assembly 48C067; refer to description of C_{1A}, C_{1B}, C_{1C} for details.</p>	<p>Antenna trimmer</p>	<p>-</p>	<p>-</p>
<p>C₃</p>	<p>Capacitor, fixed; mica dielectric; 330 mmf. \pm 20%; 500 v dcw; case 51/64" lg x 15/32" wd x 7/32" thk; two #20 AWG wire leads 1-1/8" lg; humidity resistant; same as C₄, C₅, C₈, C₉, C₁₁, C₁₃, C₅₉, C₆₁, C₆₂, C₆₃, C₇₀, C₇₂.</p>	<p>Cathode by-pass for tube V₁</p>	<p>ASA</p>	<p>CM20A331M</p>
<p>C₄</p>	<p>Same as C₃.</p>	<p>Screen by pass for tube V₁</p>	<p>-</p>	<p>-</p>

C ₅	Same as C ₃ .	Plate circuit return for tube V ₁	-	-
C ₆	Capacitor, fixed: ceramic dielectric; 5-6½ mmf; 500 vdcw; TC-0.00075 mmf/mm ² /°C; case 0.625" lg x 0.225" dia; two #22 AWG tinned copper or brass wire leads 1-½" lg; same as C ₁₀ .	Coupling between plate of tube V ₁ and control grid of tube V ₂	CRL type 807004 NTC	47A005
C ₇	Capacitor, variable; polystyrene dielectric; 2 mmf; same as C ₁₂ .	Trimmer for secondary of transformer T ₂	H Special	44A081
C ₈	Same as C ₃ .	Cathode by-pass for tube V ₂	-	-
C ₉	Same as C ₃ .	Screen by-pass for tube V ₂	-	-
C ₁₀	Same as C ₆ .	Coupling between plate of tube V ₂ and control grid of tube V ₃	-	-
C ₁₁	Same as C ₃ .	Plate circuit return for tube V ₂	-	-
C ₁₂	Same as C ₇ .	Trimmer for secondary of transformer T ₃	-	-
C ₁₃	Same as C ₃ .	Screen by-pass for tube V ₃	-	-
C ₁₄	Capacitor, fixed: mica dielectric; 6200 mmf. ± 10%; 500 vdcw; case body 53/64" square x 11/32" thk; humidity resistant; two #18 AWG wire leads 1-1/8" lg; same as C ₂₁ , C ₂₈ .	Plate circuit return for tube V ₃	ASA	CM35A622J
C ₁₅	Capacitor, fixed: ceramic dielectric; 50 mmf. ± 10%; 500 vdcw; T. C. 0.00075 max negative; body 7/16" lg x 7/32" diam; two #22 AWG wire leads 1-½" lg; part of transformer T ₅ .	Primary fixed trimmer for 1-f transformer T ₅	ER type K	47A091
C ₁₆	Same as C ₁₅ ; part of transformer T ₅ .	Secondary fixed trimmer for 1-f transformer T ₅	-	-

MODEL S-37 PARTS LIST

Ref. Symbol	Name of Part and Description	Function	Mfr Code and Type No.	Hallicrafter's Part No.
C ₁₇	Capacitor, fixed: mica dielectric; 3900 mmf \pm 10%; 500 vdcw; case 53/64" x 53/64" x 11/32"; humidity resistant; two #18 AWG wire leads 1-1/8" lg; same as C ₇₄ .	A-V-C by pass.	ASA	CM35A392K
C ₁₈	Capacitor, variable; ceramic dielectric; 2-8 mmf.; solder lug terminals; same as C ₂₆ .	Neutralize 1st i-f amplifier tube V ₄	CRL type 820-A	44A079
C ₁₉	Capacitor, fixed: mica dielectric; 5600 mmf. \pm 10%, 500 vdcw; case body 53/64" x 53/64" x 11/32"; humidity resistant; two #18 AWG wire leads 1-1/8" lg; same as C ₂₄ , C ₂₇ , C ₇₆ .	Cathode by-pass for tube V ₄	ASA	CM35A562K
C ₂₀	Capacitor, fixed: mica dielectric; 2200 mmf \pm 20%; 500 vdcw; case 53/64" x 53/64" x 9/32"; humidity resistant, two #18 AWG wire leads 1-1/8" lg.	Screen by-pass for tube V ₄	ASA	CM30A222M
C ₂₁	Same as C ₁₄ .	Plate circuit return for tube V ₄	-	-
C ₂₂	Same as C ₁₅ ; part of transformer T ₆ .	Primary fixed trimmer for i-f transformer T ₆	-	-
C ₂₃	Same as C ₁₅ ; part of transformer T ₆ .	Secondary fixed trimmer for i-f transformer T ₆	-	-
C ₂₄	Same as C ₁₉ .	Cathode by-pass for tube V ₅	-	-
C ₂₅	Capacitor, fixed: mica dielectric; 3300 mmf \pm 10%; 500 vdcw; case 53/64" x 53/64" x 9/32"; humidity resistant; two #18 AWG wire leads 1-1/8" lg.	A-V-C by-pass for tube V ₅	ASA	CM30A332K
C ₂₆	Same as C ₁₈ .	Neutralize 2nd i-f amplifier tube V ₅	-	-

C ₂₇	Same as C ₁₉ .	Screen by-pass for tube V ₅	-	-
C ₂₈	Same as C ₁₄ .	Plate circuit return for tube V ₅	-	-
C ₂₉	Same as C ₁₅ ; part of transformer T ₇ .	Primary fixed trimmer for i-f transformer T ₇	-	-
C ₃₀	Same as C ₁₅ ; part of transformer T ₇ .	Secondary fixed trimmer for i-f transformer T ₇	-	-
C ₃₁	Not used.			
C ₃₂	Capacitor, fixed: mica dielectric; 2200 mmf \pm 10%; 500 vdcw; case 53/64" x 53/64" x 9/32"; humidity resistant; two #18 AWG wire leads 1-1/8" lg; same as C ₃₃ , C ₄₃ , C ₄₄ .	Cathode by-pass for tube V ₆	ASA	CM30A222K
C ₃₃	Same as C ₃₂ .	Screen by-pass for tube V ₆	-	-
C ₃₄	Capacitor, fixed: mica dielectric; 6200 mmf \pm 5%; 500 vdcw; case body 53/64" square x 11/32" thk; humidity resistant; two #18 AWG wire leads 1-1/8 lg.	Plate circuit return for tube V ₆	ASA	CM35A622J
C ₃₅	Same as C ₁₅ ; part of transformer T ₈ .	Primary fixed trimmer for i-f transformer T ₈	-	-
C ₃₆	Same as C ₁₅ ; part of transformer T ₈ .	Secondary fixed trimmer for i-f transformer T ₈	-	-
C ₃₇	Capacitor, fixed: mica dielectric; 47 mmf \pm 10%; 500 vdcw; case 51/64" x 51/64" x 9/32"; humidity resistant; two #20 AWG wire leads 1-1/8" lg; same as C ₃₈ , C ₄₆ .	R-F filter in diode load	ASA	CM20A470K
C ₃₈	Same as C ₃₇ .	R-F filter in diode load	-	-
C ₃₉	Capacitor, fixed: paper dielectric; 0.05 mfd \pm 20%; 400 vdcw; molded bakelite case 1-7/16" lg x 3/4" wd x 3/8" thk; two #20 AWG wire leads 1-1/2" lg.	A-N-L return for tube V ₇	MIC type 345	46A1503H
C ₄₀	Capacitor, fixed: ceramic dielectric; 25 mmf \pm 10%; 500 vdcw; T.C. negative 0.00075 mmf/mmfd/degree C; body 0.825" lg x 0.225" diam; two #22 AWG wire leads 1-1/2" lg; part of discriminator transformer T ₉ .	Discriminator transformer coupling	ER type K	47A103

MODEL S-37 PARTS LIST

Ref. Symbol	Name of Part and Description	Function	Mfr Code and Type No.	Hallicrafter's Part No.
C ₄₁	Same as C ₁₅ ; part of discriminator transformer T ₉ .	Primary tuning for discriminator transformer T ₉	-	-
C ₄₂	Same as C ₁₅ ; part of discriminator transformer T ₉ .	Secondary tuning for discriminator transformer T ₉	-	-
C ₄₃	Same as C ₃₂ .	Plate circuit return for tube V ₈	-	-
C ₄₄	Same as C ₃₂ .	Screen by-pass for tube V ₈	-	-
C ₄₅	Capacitor, fixed: mica dielectric; 470 mmf ± 10%; 500 vdcw; case 51/64" x 15/32" wd x 7/32" thk; humidity resistant; two #20 AWG wire leads 1-1/8" lg; same as C ₄₇ .	A-V-C circuit by-pass at tube V ₈	ASA	CM20A471K
C ₄₆	Same as C ₃₇ .	Cathode circuit by-pass at tube V ₉	-	-
C ₄₇	Same as C ₄₅ .	Part of de-emphases circuit	-	-
C ₄₈	Capacitor, fixed: mica dielectric; 8200 mmf ± 10%; 500 vdcw; case 53/64" x 53/64" x 11/32"; humidity resistant; two #18 AWG wire leads 1-1/8" lg; same as C ₅₁ , C ₅₂ , C ₆₄ , C ₆₅ , C ₆₆ , C ₆₇ .	A-F coupling to grid of tube V ₁₀	ASA	CM35A822K
C ₄₉	Capacitor, fixed: electrolytic; 20 mfd -20 + 50%; 100 vdcw; bathtub metal case 1-3/4" lg x 1" wd x 13/16" h, excluding lugs; two mtg lugs with 2-1/8" mtg/c; two solder lug terminals; same as C ₅₀ .	Cathode by-pass for tube V ₁₀	IC type 100BE20	45B033
C ₅₀	Same as C ₄₉ .	Cathode by-pass for tube V ₁₁	-	-

C ₅₁	Same as C ₄₈ .	Tone control capacitor at tube V ₁₁	-	-
C ₅₂	Same as C ₄₈ .	A-F coupling at grid of tube V ₁₁	-	-
C ₅₃	Capacitor, fixed: paper dielectric; 0.005 mfd \pm 20%; 1000 vdcw; round metal case 2- $\frac{1}{2}$ " h x 11/16" diam; oil filled; one mtg hole 9/16" from center of unit on mtg base; mtg hole .178/.188" diam.; base is one terminal, solder lug on top is other terminal.	Plate circuit by-pass for tube V ₁₁	IC	46A007
C ₅₄	Capacitor, fixed: paper dielectric; 4 mfd. \pm 10%, 600 vdcw; tubular metal case 4-1/2" lg x 1-1/2" diam. over-all; mtd by bushing having 3/4-16 NF-2 thd, nut and lock washer included; solder lug is one terminal, can is other terminal; same as C ₅₅ , C ₅₆ , C ₅₇ , C ₅₈ .	Power supply filter	CD type TL6040	46A018
C ₅₅	Same as C ₅₄ .	Power supply filter	-	-
C ₅₆	Same as C ₅₄ .	Power supply filter	-	-
C ₅₇	Same as C ₅₄ .	Power supply filter	-	-
C ₅₈	Same as C ₅₄ .	Power supply filter	-	-
C ₅₉	Same as C ₃ .	R-F by-pass at filament of tube V ₃	-	-
C ₆₀	Capacitor, fixed: mica dielectric; 330 mmf \pm 10%; 500 vdcw; case 51/64 lg x 15/32" wd x 7/32" thk; humidity resistant; two #20 AWG wire leads 1-1/8" lg.	R-F by-pass at filament of tube V ₃	ASA	CM20A331K
C ₆₁	Same as C ₄₅ .	R-F by-pass at filament of tube V ₁₄	-	-
C ₆₂	Same as C ₃ .	R-F by-pass at filament of tube V ₂	-	-
C ₆₃	Same as C ₃ .	R-F by-pass at filament of tube V ₁	-	-
C ₆₄	Same as C ₄₈ .	A-C line filter	-	-
C ₆₅	Same as C ₄₈ .	A-C line filter	-	-

MODEL S-37 PARTS LIST

Ref. Symbol	Name of Part and Description	Function	Mfr. Code and Type No.	Hallicrafter's Part No.
C ₆₆	Same as C ₄₈ .	A-C line filter	-	-
C ₆₇	Same as C ₄₈ .	A-C line filter	-	-
C ₆₈	Capacitor, fixed: silver mica dielectric; 150 mmf \pm 20%; 500 vdcw; button type; 13/32" x 29/64" diam; 2 solder lug terminals; mtg hole tapped #3-48 x 11/64" d.	Grid return by-pass for tube V ₁₄	ER type 370-A	47A135
C ₆₉	Not used.			
C ₇₀	Same as C ₃ .	Cathode return for tube V ₃	-	-
C ₇₁	Capacitor, fixed: ceramic dielectric; 100 mmf \pm 5 mmf; 500 vdcw; T.C. positive 0.0007 mmf/mmfd/degree C; body 11/16" lg x 7/32" diam; vacuum wax impregnated; two #20 AWG wire leads 1-1/2" lg; part of oscillator transformer T ₄ .	R-F coupling for plate of tube V ₁₄	ER type N-750L	47A108
C ₇₂	Same as C ₄₅ .	Plate circuit by-pass for tube V ₁₄	-	-
C ₇₃	Same as C ₁₅ ; part of transformer T ₇ .	Grid coupling for tube V ₈	-	-
C ₇₄	Same as C ₁₇ .	A-V-C by-pass for tubes V ₄ and V ₅	-	-
C ₇₅	Not used.			
C ₇₆	Same as C ₁₉ .	Hash filter for tube V ₁₂	-	-
F ₁	Fuse, cartridge: 3 amp 250-volt; 3 AG; glass enclosed; ferrule caps; same as F ₂ .	Line fuse	LF type 1043	39A301
F ₂	Same as F ₁ .	Line fuse	-	-
J ₁	Jack, telephone: headphone; short; takes standard tip and sleeve; mounts by bushing 3/8"-32x3/8"; furnished with one brass hex nut and one brass ni pl 5/8" OD washer; solder lug terminals.	Headphone connection	U type ST-627	36B011

L ₁	Coil, r-f: 15.5 uh \pm 10%; distributed capacity 1 mmf \pm 20%; d-c resistance 4.10 ohms \pm 3%; "Q" with 100 mmf capacity 65 \pm 15%; 75 turns #38 SCC wire on molded natural bakelite rod 15/16" lg x 5/32" diam; two wire leads 1- $\frac{1}{2}$ " lg; Chinese red laquer coating.	Oscillator plate choke, tube V ₁₄	SWI Special	53A008
L ₂	Coil, filter: line; 46 uh; 57 turns #22 SCE wire, universal winding; wound on glazed ceramic form 1" lg x $\frac{1}{2}$ " diam, tapped #6-32 x 7/16 d; winding is 1" lg x 1-1/16" diam; two extended leads with spaghetti covering; tape over spaghetti and leads to prevent leads breaking; same as L ₃ .	A-C line filter	SWI Special	53A095
L ₃	Same as L ₂ .	A-C line filter	-	-
L ₄	Coil, filter: input; 2 henries \pm 15%; rated d-c current 150 ma; d-c resistance 85 ohms \pm 10%; iron core; 1850 turns of #31 enameled copper wire; metal case 2-5/8" h x 2-3/16" wd x 2-11/16" lg; mtg flange has six mtg holes, 3 on each side, of 3/16" diam, spaced 3/4" apart, on 2-3/8" mtg centers; two lug terminals on top of case, each terminal 3/16" diam, spaced 5/8" apart; coil is vacuum wax impregnated; voltage breakdown 2400 volts A.M.S. between coil and core or coil and case.	Power supply input filter choke	CTC type 7488	56B011
L ₅	Coil, filter: output; 12 henries; rated d-c current 90 ma; d-c resistance 298 ohms at 75°C; test voltage 2400 volt r.m.s. between coil and core or coil and case; hermetically sealed in metal case 3-1/16" h x 2-3/8" wd x 2- $\frac{1}{2}$ " lg; four #8-32 NC thread mtg studs on 1- $\frac{1}{2}$ " x 1-3/4" mtg centers; hardware included; two lug terminals on top spaced 23-32" apart.	Power supply output filter choke	CTC type 7645	56B012

MODEL S-37 PARTS LIST

Ref. Symbol	Name of Part and Description	Function	Mfr Code and Type No.	Hallicrafter's Part No.
L ₆	Coil, r-f: 4.2 uh \pm 10%; distributed capacity 1 mmf \pm 20%; d-c resistance 0.25 ohms \pm 10%; "Q" with 100 mmf capacitor 100 \pm 20%; 42 turns #28 ESCC copper wire on molded natural bakelite form 7/8" lg x 9/32" diam; Chinese blue lacquer coated; two copper wire leads 1- $\frac{1}{4}$ " lg.	Oscillator tube filament choke	SWI Special	53A009
LM ₁	Lamp, incandescent: pilot; 6-8 volt, 0.15 amp; bayonet type base.	Vernier scale illumination	GE type 47	39A004
LM ₂	Same as LM ₁ .	Meter scale illumination	-	-
PL ₁	Connector, male contact: octal; molded bakelite body, 1" lg x 1- $\frac{1}{4}$ " diam overall; prongs are numbered from 1 to 8 on both sides; includes insulated jumper between 3 and 4 and one between 6 and 7.	D-C power plug	AP type CP-8	35A003
M ₁	Meter, micro ammeter: range 160-0-40 microamperes; accuracy \pm 20% of full scale length 1.65" covered in 90° of pointer swing; approx resistance 1250 ohms d-c; damping factor 8 (full scale length); metal case 1-3/16 d x 2- $\frac{1}{2}$ " diam; mtd by metal flange 3- $\frac{1}{4}$ " diam having 3 mtg holes 1/8" diam spaced 120° apart on 1-3/16" radius; two stud terminals at rear $\frac{1}{2}$ " long x #10-32 thread; flange is part of case.	"S" meter	B Special	82A036
R ₁	Resistor, fixed: 2.2 ohm \pm 10%; $\frac{1}{2}$ watt; composition; insulated; 7/16" lg x 0.215" diam; two #18 AWG leads 1- $\frac{1}{2}$ " lg; part of transformer T ₁ .	Parasitic suppressor for tube V ₁	ER type 504	23A016

R ₂	Resistor, fixed: 270 ohm \pm 10%; $\frac{1}{2}$ watt; composition; humidity resistant; insulated; 0.655" lg x 0.249 diam; two #21 AWG wire leads 1- $\frac{1}{2}$ " lg; same as R ₅ , R ₄₄ .	Cathode bias for tube V ₁	ASA	RC21AE271K
R ₃	Resistor, fixed: 1000 ohm \pm 20%; $\frac{1}{2}$ watt; composition; humidity resistant; insulated; 0.655" lg x 0.249" diam; two #21 AWG wire leads 1- $\frac{1}{2}$ " lg; same as R ₄ , R ₆ , R ₇ , R ₉ , R ₁₀ , R ₂₃ , R ₂₉ .	Voltage drop for screen of tube V ₁	ASA	RC21AE102M
R ₄	Same as R ₃ .	Decoupling for plate circuit of tube V ₁	-	-
R ₅	Same as R ₂ .	Cathode bias for tube V ₂	-	-
R ₆	Same as R ₃ .	Voltage drop for screen of tube V ₂	-	-
R ₇	Same as R ₃ .	Decoupling for plate circuit of tube V ₂	-	-
R ₈	Resistor, fixed: 12,000 ohms \pm 10%; 2 watt; composition; insulated; humidity resistant; 1.78" lg x 0.342" diam; two #19 AWG wire leads 1-1/2" lg.	Plate voltage dropping resistor for tubes V ₁ and V ₂	ASA	RC41AE123K
R ₉	Same as R ₃ .	Voltage drop for screen of tube V ₃	-	-
R ₁₀	Same as R ₃ .	Decoupling for plate circuit of tube V ₃	-	-
R ₁₁	Resistor, fixed: 33 ohm \pm 10%; $\frac{1}{2}$ watt; composition; insulated; humidity resistant; 0.655" lg x 0.249" diam; two #21 AWG wire leads 1- $\frac{1}{2}$ " lg; same as R ₂₁ , R ₂₅ , R ₃₉ , R ₆₄ .	Parasitic suppressor for tube V ₄	ASA	RC21AE330K
R ₁₂	Resistor, fixed: 100,000 ohm \pm 10%; $\frac{1}{2}$ watt; composition; insulated; humidity resistant; 0.468" lg x 0.249" diam; two #21 AWG wire leads 1- $\frac{1}{2}$ " lg; part of transformer T ₅ . Same as R ₁₉ , R ₄₅ , R ₄₆ .	A-V-C decoupling for tube V ₄	ASA	RC20AE104K

MODEL S-37 PARTS LIST

Ref. Symbol	Name of Part and Description	Function	Mfr Code and Type No.	Hallicrafter's Part No.
R ₁₃	Resistor, fixed: 100,000 ohm \pm 10%; $\frac{1}{2}$ watt; composition; insulated; humidity resistant; 0.655" lg x 0.249" diam; two #21 AWG wire leads 1- $\frac{1}{2}$ " lg; same as R ₁₅ , R ₃₃ .	A-V-C decoupling for tube V ₄	ASA	RC21AE104K
R ₁₄	Resistor, fixed: 330 ohm \pm 10%; $\frac{1}{2}$ watt; composition; insulated; humidity resistant; 0.655" lg x 0.249" diam; two #21 AWG wire leads 1- $\frac{1}{2}$ " lg; same as R ₂₄ , R ₅₃ , R ₆₀ .	Cathode bias for tube V ₄	ASA	RC21AE331K
R ₁₅	Same as R ₁₃ .	Part of r-f gain control circuit	-	-
R ₁₆	Resistor, variable: 10,000 ohm \pm 20%; carbon; #8 reversed taper; shaft 1" long x $\frac{1}{4}$ " diam; 3 solder lug terminals; center lug is variable contact; includes switch SW ₃ .	R-F Gain control	CT type 135	25C058
R ₁₇	Resistor, fixed: 39,000 ohm \pm 10%; $\frac{1}{2}$ watt; composition; insulated; humidity resistant; 0.655" lg x 0.249" diam; two #21 AWG wire leads 1- $\frac{1}{2}$ " lg.	Voltage drop for screen of tube V ₄	ASA	RC21AE393K
R ₁₈	Resistor, variable: 330 ohm \pm 20%; $\frac{1}{2}$ watt; composition; insulated; humidity resistant; 0.655" lg x 0.249" diam; two #21 AWG wire leads 1- $\frac{1}{2}$ " lg.	Decoupling for plate circuit of tube V ₄	ASA	RC21AE331M
R ₁₉	Same as R ₁₂ ; part of transformer T ₆ .	A-V-C decoupling for tube V ₅	-	-
R ₂₀	Resistor, fixed: 100,000 ohm \pm 20%; $\frac{1}{2}$ watt; composition; insulated; humidity resistant; 0.655" lg x 0.249" diam; two #21 AWG wire leads 1- $\frac{1}{2}$ " lg; same as R ₃₇ , R ₄₅ , R ₄₆ .	A-V-C decoupling for tube V ₅	ASA	RC21AE104M
R ₂₁	Same as R ₁₁ .	Parasitic suppressor for tube V ₅	-	-

R ₂₂	Resistor, fixed: 150 ohm \pm 10%; $\frac{1}{2}$ watt; composition; insulated; humidity resistant; 0.655" lg x 0.249" diam; two #21 AWG wire leads 1- $\frac{1}{2}$ " lg.	Cathode bias for tube V ₅	ASA	RC21AE151K
R ₂₃	Same as R ₃ .	Voltage drop for screen of tube V ₅	-	-
R ₂₄	Same as R ₁₄ .	Decoupling for plate circuit of tube V ₅	-	-
R ₂₅	Same as R ₁₁ .	Meter shunt, A-M operation	-	-
R ₂₆	Not used			
R ₂₇	Resistor, fixed: 560 ohm \pm 10%; $\frac{1}{2}$ watt; composition; insulated; humidity resistant; 0.655" lg x 0.249" diam; two #21 AWG wire leads 1- $\frac{1}{2}$ " lg.	Cathode bias for tube V ₆	ASA	RC21AE561K
R ₂₈	Resistor, fixed: 7500 ohm \pm 10%; 10 watt; wire wound; vitreous baked enameled coated; 1-3 $\frac{1}{4}$ " lg x 3/8" max diam; two #18 AWG wire leads 1-3/8" lg.	Voltage drop for screens of tubes V ₁ , V ₂ , V ₆ and V ₈ .	U type CC	24BG752E
R ₂₉	Same as R ₃ .	Voltage drop for screen of tube V ₆	-	-
R ₃₀	Resistor, fixed: 1000 ohm \pm 10%; $\frac{1}{2}$ watt; composition; insulated, humidity resistant; 0.655" lg x 0.249" diam; two #21 AWG wire leads 1- $\frac{1}{2}$ " lg.	Decoupling for plate circuit of tube V ₆	ASA	RC21AE102K
R ₃₁	Resistor, fixed: 47,000 ohm \pm 10%; $\frac{1}{2}$ watt; composition; insulated; humidity resistant; 0.655" lg x 0.249" diam; two #21 AWG wire leads 1- $\frac{1}{2}$ " lg; same as R ₃₈ .	Diode load for tube V ₇	ASA	RC21AE473K
R ₃₂	Resistor, fixed: 1 megohm \pm 20%; $\frac{1}{2}$ watt; composition; insulated; humidity resistant; 0.655" lg x 0.249" diam; two #21 AWG wire leads 1- $\frac{1}{2}$ " lg.	A-N-L decoupling	ASA	RC21AE105M
R ₃₃	Same as R ₁₃ .	Diode load for tube V ₇	-	-

MODEL S-37 PARTS LIST

Ref. Symbol	Name of Part and Description	Function	Mfr Code and Type No.	Hallicrafter's Part No.
R ₃₄	Resistor, fixed: 270,000 ohm \pm 10%; $\frac{1}{2}$ watt; composition; insulated; humidity resistant; 0.655" lg x 0.249" diam; two #21 AWG wire leads 1- $\frac{1}{2}$ " lg; same as R ₃₅ , R ₄₁ , R ₅₀ .	Diode load for tube V ₇	ASA	RC21AE274K
R ₃₅	Same as R ₃₄ .	Diode load for tube V ₇	-	-
R ₃₆	Resistor, fixed: 470,000 ohm \pm 20%; $\frac{1}{2}$ watt; composition; insulated; humidity resistant; 0.655" lg x 0.249" diam; two #21 AWG wire leads 1- $\frac{1}{2}$ " lg.	A-V-C decoupling for tubes V ₄ and V ₅ in A.M. operation	ASA	RC21AE474M
R ₃₇	Same as R ₂₀ .	A-V-C decoupling for tubes V ₄ and V ₅ in F.M. operation	-	-
R ₃₈	Same as R ₃₁ .	Grid return for tube V ₈	-	-
R ₃₉	Same as R ₁₁ .	Parastic suppressor for grid of tube V ₈	-	-
R ₄₀	Resistor, fixed: 3,900 ohm \pm 10%; 2 watt; composition; insulated; humidity resistant; 1.78" lg x 0.242" diam; two #19 AWG wire leads 1- $\frac{1}{2}$ " lg.	Voltage drop for screen of tube V ₈	ASA	RC41AE392K
R ₄₁	Same as R ₃₄ .	Grid return for tube V ₈	-	-
R ₄₂	Resistor, fixed: 3300 ohm \pm 10%; 1 watt; composition; insulated; humidity resistant; 1.28" lg x 0.310" diam; two #20 AWG wire leads 1- $\frac{1}{2}$ " lg.	Load for screen voltage on tube V ₈	ASA	RC31AE332K
R ₄₃	Resistor, fixed: 330,000 ohm \pm 10%; $\frac{1}{2}$ watt; composition; insulated; humidity resistant; 0.655" lg x 0.249" diam; two #21 AWG wire leads.	"S" meter current limiting for F.M. operation	ASA	RC21AE334K

R ₄₄	Same as R ₂ .	Decoupling for plate circuit of tube V ₈	-	-
R ₄₅	Same as R ₁₂ ; part of transformer T ₉ .	F.M. diode load for tube V ₉	-	-
R ₄₆	Same as R ₁₂ ; part of transformer T ₉ .	F.M. diode load for tube V ₉	-	-
R ₄₇	Resistor, fixed: 220,000 ohm \pm 20%; $\frac{1}{2}$ watt; composition; insulated; humidity resistant; 0.655" lg x 0.249" diam; two #21 AWG wire leads 1- $\frac{1}{2}$ " lg.	De-emphasis network for tube V ₉	ASA	RC21AE224M
R ₄₈	Resistor, variable: 1 megohm \pm 20%; carbon; #6 taper; shaft 1" long x $\frac{1}{8}$ " diam; 3 solder lug terminals with variable contact located in the center and fixed contacts 1-7/16" apart; no taps.	A-F GAIN control	CRL type 1-010	25C059
R ₄₉	Resistor, fixed: 3300 ohm \pm 10%; $\frac{1}{2}$ watt; composition; insulated; humidity resistant; 0.655" lg x 0.249" diam; two #21 AWG wire leads 1- $\frac{1}{2}$ " long.	Cathode bias for tube V ₁₀	ASA	RC21AE332K
R ₅₀	Same as R ₃₄ .	Plate load for tube V ₁₀	-	-
R ₅₁	Resistor, fixed: 470,000 ohm \pm 10%; $\frac{1}{2}$ watt; composition; insulated; humidity resistant; 0.655" lg x 0.249" diam; two #21 AWG wire leads 1- $\frac{1}{2}$ " lg.	Grid return for tube V ₁₁	ASA	RC21AE474K
R ₅₂	Resistor, variable: 500,000 ohm \pm 20%; carbon; #6 taper; shaft 1" lg x $\frac{1}{8}$ " diam; 3 solder lug terminals with variable contact between the outer lug terminals; terminals 1-7/16" apart; no taps.	TONE control	CT type 31	25C065
R ₅₃	Same as R ₁₄ .	Cathode bias for tube V ₁₁	-	-
R ₅₄	Resistor, fixed; 4700 ohm \pm 20%; 1 watt; composition; insulated; humidity resistant; 1.28" lg x 0.310" diam; two #20 AWG wire leads 1- $\frac{1}{2}$ " lg.	Output load, phone operation	ASA	RC31AE472M

MODEL S-37 PARTS LIST

Ref. Symbol	Name of Part and Description	Function	Mfr Code and Type No.	Hallicrafter's Part No.
R ₅₅	Resistor, variable: 1500 ohm \pm 20%; wire wound; st line taper; shaft 3/8" long x 1/4" diam, slotted 1/16" x 1/16"; 3 solder lug terminals with variable contact located in the center and fixed contacts 1-7/16" apart; no taps.	S METER ADJ. control	CT type 125	25C060
R ₅₆	Resistor, fixed: 3,200 ohm \pm 10%; 10 watt; wire wound; vitreous enamel coated; 1-3/4" lg x 3/8" max diam; two #18 AWG wire leads 1-3/8" long.	Voltage drop for regulator tube V ₁₂	U type CC	24BG322E
R ₅₇	Resistor, fixed: 22,000 ohm \pm 20%; 1/2 watt; composition; insulated; humidity resistant; 0.655" lg x 0.249" diam; two #21 AWG wire leads 1-1/2" lg.	Grid return for tube V ₁₄	ASA	RC21AE223M
R ₅₈	Resistor, fixed: 3900 ohm \pm 10%; 1/2 watt; composition; insulated; humidity resistant; 0.655" lg x 0.249" diam; two #21 AWG wire leads 1-1/2" lg.	Cathode bias for tube V ₃	ASA	RC21AE392K
R ₅₉	Resistor, fixed: 5,600 ohm \pm 10%; 1/2 watt; composition; insulated; humidity resistant; 0.655" lg x 0.249" diam; two #21 AWG wire leads 1-1/2" lg.	Decoupling for plate circuit of tube V ₁₄	ASA	RC21AE562K
R ₆₀	Same as R ₁₄ .	Decoupling for plate circuit of tube V ₁₄	-	-
R ₆₁	Resistor, fixed: 150,000 ohm \pm 20%; 1/2 watt; composition; insulated; humidity resistant; 0.655" lg x 0.249" diam; two #21 AWG wire leads 1-1/2" lg.	Voltage drop for screen of tube V ₃	ASA	RC21AE154M
R ₆₂	Resistor, fixed: 8 ohm \pm 10%; 1/2 watt; composition; insulated; humidity resistant; 7/16" lg x 0.215" diam; two #21 AWG wire leads.	Parasitic suppressor at grid of tube V ₁₄	ER type 504	23A019

R ₆₃	Resistor, fixed: 27,000 ohm \pm 10%; $\frac{1}{2}$ watt; composition; insulated; humidity resistant; 0.468" lg x 0.249" diam; two #21 AWG leads 1- $\frac{1}{2}$ " lg. Part of transformer T ₉ .	Primary load for transformer T ₉	ASA	RC20AE273K
R ₆₄	Same as R ₁₁ .	Voltage dropping for plate of tube V ₃	-	-
SO ₁	Connector, female contact: octal; high dielectric mica filled bakelite body, 1-7/64" diam x 31/64" thick; silver plated phosphor bronze solder lugs; molded on steel mtg plate 1-9/32" wd x 0.031" thk having 2 mtg holes of 5/32" diam x 1- $\frac{1}{2}$ " mtg centers; pins are numbered on back of socket clockwise from locating pin.	D-C power input connection	AP type M1P8TM	6A200
SO ₂	Connector, female contact: two terminal; bakelite body, 11/16" wd x 3/8" h x 23/32" d + thickness of mtg plate; mounted by cad plated steel plate having 2 mtg holes with 1-1/8" mtg centers; 2 solder lug terminals 5/16" lg x $\frac{1}{4}$ " wd, rated 10 amp at 250 volts, 15 amp at 125 volts.	External stand-by switch connection	AL type 4002-T	10A015
SO ₃	Connector, male contact: recessed; two brass prongs; screw type terminals; 1-3/4" x 1-5/8" x 1- $\frac{1}{4}$ " overall; molded bakelite body recessed in metal cup 1-3/8" diam with flange type mtg having 1-3/4" mtg centers, mtg holes 0.144" diam.	A-C line plug	AP type 60M-10	10A047
SW ₁	Switch, toggle; SPST; power; rated 3 amp at 250-volt; black enamel steel case 13/16" h x 15/32" d x $\frac{1}{2}$ " wd; 2 solder lug terminals; mounts by brass bushing 15/32" - 32 to fit a 3/8" hole; mechanism is brass; lugs separated by fibre piece; same as SW ₂ , SW ₅ .	POWER switch	HH type 20894	60A116
SW ₂	Same as SW ₁ .	SEND-REC. stand-by switch	-	-

MODEL S-37 PARTS LIST

Ref. Symbol	Name of Part and Description	Function	Mfr Code and Type No.	Hallicrafter's Part No.
SW ₃	Switch, toggle: SPST; mounts on back of R.F. GAIN control and closes when the R.F. GAIN control is turned all the way to the right (clockwise); part of R.F. GAIN control.	"S" Meter switch	-	-
SW _{4A} SW _{4B} SW _{4C} SW _{4D}	Switch, rotary: single section; 2 position; all metal parts silver plated brass except for stainless steel index spring and ball; vacuum wax impregnated phenolic wafer; non shorting teeth of contacts 5 and 8; frame 5/16" lg; mts by 3/8-32 bushing 1/2" lg, shaft 1" lg x 1/2" diam.	A.M.-F.M. switch	OM type GH	60A177
SW ₅	Same as SW ₁ .	A.V.C. switch	-	-
SW ₆	Switch, toggle: DPST; rated 1 amp at 250-volts, 3 amp at 125-volts; metal case, 1-9/16" x 19/32" overall diam; includes fibre separators in assembly; 4 brass lug terminals; mts by brass bushing 15/32-32 x 13/32".	A.N.L. switch	HH	60A117
T ₁	Transformer, r-f: sec, 2 turns of 1/8" O.D. x 1/16" I.D. copper tubing, silver plated; pri, 1-1/2 turns of #28 tinned & single braided celanese wire strung thru hollow sec; grid lead, stranded voice coil wire 3/41 lg; spacing between sec turns not less than 1/32"; coil wound on polystyrene form 1-13/16" lg x 3/8" diam; includes resistor R ₁ , mounted thru center of form 1/2" from top end; one lead of resistor soldered to sec about 1-3/4 turns from winding start; the other lead is cut short and the grid lead with acorn tube clip is attached; the start end of the sec extends 27/32" from the center of the coil form and is flatted 3/16" from the end; the finish end of the secondary extends 13/16" from the	Antenna coil	EW Special	51A350

center of the coil form; the primary terminal are two solder lug terminals which are mounted on a ceramic terminal $5/8"$ wd x $3/4"$ h x $5/32"$ thk which is mtd near the bottom of the coil form by a $1/2"$ nickel plated brass screw; start and finish leads of sec extend from coil at a 90 degree angle.

T₂

Transformer, r-f: pri, $2-1/2$ turns of #32 enameled single silk covered wire; spaced one wire diam; sec, 2 turns of silver plated copper tubing $1/8"$ O.D. x $1/16"$ I.D.; grid lead is voice coil wire $1-1/2"$ lg with acorn tube clip and soldered on sec 2 turns from winding start; spacing between sec turns not less than $1/32"$; the start end of the sec extends $3/4"$ from center of coil form and flatted $3/16"$ from end; the finish end extends $15/16"$ from center of coil form; coils are wound on polystyrene from $1-7/16"$ lg x $3/8"$ diam at one end and $5/16"$ diam at other end; secondary leads terminate as two solder lug terminals which are mtd on a ceramic terminal $5/8"$ wd x $3/4"$ h x $5/32"$ thk which mounts to coil form by a $1/2"$ nickel plated brass screw; grid lead insulated by 2 Amphenol "912" beads #73-1; start and finish leads of sec extend from coil at a 90 degree angle.

1st r-f coil

EW
Special

51A351

T₃

Transformer, r-f: pri, $3-3/4"$ turns of #32 enameled single silk covered wire spaced not less than $1/32"$ between turns; sec, $1-1/2$ turns of silver plated copper tubing, $1/8"$ O.D. x $1/16"$ I.D.; grid lead is voice coil wire $1-3/4"$ lg with acorn tube clip at one end, other end soldered to sec 1 turn from start end; start end of sec extends $1-1/32"$ from center of coil and is flatted $3/16"$ from end; finish end of sec extends $13/16"$ from center of coil; start and finish end of coil extend at a 90 degree angle; pri leads terminate at two solder lug terminals which are mounted on a ceramic terminal $5/8"$

Converter or 2nd r-f coil

EW
Special

51A352

MODEL S-37 PARTS LIST

Ref. Symbol	Name of Part and Description	Function	Mfr Code and Type No.	Hallicrafter's Part No.
T ₄	<p>wd x 3/4" h x 5/32" thk mounted on coil form by a 1/2" nickel plated brass screw; grid lead is insulated by 3 amphenol "912" beads #73-1.</p> <p>Transformer, r-f: pri, 1-1/2 turns of #16 tinned copper wire; sec, 1-1/2 turns of silver plated copper tubing 1/8" O.D. x 1/16" I.D.; sec winding spaced 1/32"; sec leads are 1-1/2" and 1-3/32" lg respectively; pri leads are 1-3/4" wd 1-1/2" lg respectively and extending from the coil at a 90 degree angle; capacitor C₇₁ is soldered 1 turn from longest lead of sec; coils are wound on polystyrene from 1-1/2" lg x 3/8" diam; pri is slightly sealed to coil form for shipping, seal may easily be broken for adjustment.</p>	Oscillator coil	EW Special	51A353
T ₅	Transformer, IF: 16 megacycles; input stage; shielded; shield can 1-7/8" lg x 1-7/16" wd x 4" h; powdered iron core; tuned primary and secondary; adjustable iron core tuning; spade lug mtg on 1-7/8" x 1-7/16" mtg centers; 8 solder lug terminals at base; includes capacitors C ₁₅ and C ₁₆ and resistor R ₁₂ .	1st IF transformer	EW Special	50C165
T ₆	Transformer, IF: 16 megacycles; interstage; shielded; shield can 1-7/8" lg x 1-7/16" wd x 4" h; powdered iron core; tuned primary and secondary; adjustable iron core tuning; spade lug mtg on 1-7/8" x 1-7/16" mtg centers; 8 solder lug terminals at base; includes capacitors C ₂₂ and C ₂₃ , and resistor R ₁₉ .	2nd IF transformer	EW Special	50C166

T ₇	Transformer, IF: 16 megacycles; interstage; shielded; shield can 1-7/8" lg x 1-7/16" wd x 4" h; powdered iron core; tuned primary and secondary; adjustable iron core tuning; spade lug mtg on 1-7/8" x 1-7/16" mtg centers; 8 solder lug terminals at base; includes capacitors C ₂₉ , C ₃₀ and C ₇₃ .	3rd IF transformer	EW Special	50C167
T ₈	Transformer, IF: 16 megacycles; diode; shielded; shield can 1-7/8" lg x 1-7/16" wd x 4" h; powdered iron core; tuned primary and secondary; adjustable iron core tuning; spade lug mtg on 1-7/8" x 1-7/16" mtg centers; 8 solder lug terminals at base; includes capacitors C ₃₅ and C ₃₆ .	Diode IF transformer	EW Special	50C168
T ₉	Transformer, IF: 16 megacycles; discriminator; shielded; shield can 1-7/8" lg x 1-7/16" wd x 4" h; powdered iron core; tuned primary and secondary; adjustable iron core tuning spade lug mtg on 1-7/8" x 1-7/16" mtg centers; 8 solder lug terminals at base; includes capacitors C ₄₀ , C ₄₁ and C ₄₂ , and resistors R ₄₅ , R ₄₆ and R ₆₃ .	Discriminator IF transformer	EW Special	50C169
T ₁₀	Transformer, AF: audio output; two windings; primary to match output of tube V ₁₁ (6V6GT), secondary to match 5000 ohm load; tapped to match 500 ohm load; enclosed in metal case.	Couples tube V ₁₁ to external load	H Special	55B012
T ₁₁	Transformer, power: filament; primary for 230 volts, 50 cycles with tap for 115-volts; #1 secondary 3 amp 5 volts; #2 secondary 4 amp 6.3 volts; coil and core potted and sealed in metal case 3-15/16" x 3-1/4" x 4" overall, 2 mtg flanges each having 3 mtg holes 7/32" diam spaced 1-1/8" apart, 2 sets of mtg holes have 3-1/2" x 2-1/4" mtg centers.	Filament power supply	H Special	52A044

MODEL S-37 PARTS LIST

Ref. Symbol	Name of Part and Description	Function	Mfr Code and Type No.	Hallicrafter's Part No.
T ₁₂	Transformer, power: plate; primary 230 volts, 50 cycles with tap for 115 volts; secondary 280 volts each side of center tap, 150 ma using 5U4G full wave rectifier and 10 mfd filter capacity; coil and core potted and sealed in metal case, 4-3/8" h x 3-21/32" wd x 3-21/32" d; 2 mtg flanges each having 3 mtg holes 7/32" diam spaced 1-3/8" apart, mtg centers 3-7/8" x 2-3/4".	Plate and screen power supply	H Special	52A043
TS ₁	Board, terminal: mounts three brass, cadmium plated binding posts and nuts, and has two brass cadmium plated mtg inserts; base of black BM120 or 262 high impact bakelite; base 2-3/8" lg x 7/8" wd x 3/16" thk; mtg inserts centered on 3/4" x 1/2" mtg centers, have 0.144" clearance ID.	Antenna and grid connections	H Special	11B163
TS ₂	Board, terminal: mounts two brass, cadmium plated binding posts and nuts, and has two brass cadmium plated mtg inserts; base of black BM120 or 262 high impact bakelite; base 1-5/8" lg x 7/8" wd x 3/16" thk; mtg inserts centered on 1/2" mtg centers have 0.144" clearance ID, same as TS ₃ .	5000 ohm output connection	H Special	11B162
TS ₃	Same as TS ₂ .	500 ohm output connection	-	-
V ₁	Tube, detector amplifier pentode (acorn type); same as V ₂ , V ₃ .	1st r-f amplifier	RCA type 954	90X954
V ₂	Same as V ₁ .	2nd r-f amplifier	-	-
V ₃	Same as V ₁ .	Mixer	-	-

V₄ Tube, television amplifier pentode, same as V₈.

V₅ Tube, television amplifier pentode.

V₆ Tube, triple-grid super-control amplifier.

V₇ Tube, twin diode; same as V₉.

V₈ Same as V₄.

V₉ Same as V₇.

V₁₀ Tube, twin-triode amplifier.

V₁₁ Tube, beam power amplifier.

V₁₂ Tube, voltage regulator (Glow discharge type).

V₁₃ Tube, full-wave high-vacuum rectifier.

V₁₄ Tube, detector, amplifier, oscillator (acorn type).

1st i-f amplifier	RCA type 6AC7	✓	90X6AC7
2nd i-f amplifier	RCA type 6AB7		90X6AB7
3rd i-f amplifier	RCA type 6SK7		90X6SK7
2nd detector A-N-L, A-V-C	RCA type 6H6	✓	90X6H6
F-M limiter	-		-
F-M discriminator	-		-
Audio voltage amplifier	RCA type 6SL7GT	✓	90X6SL7GT
Audio power amplifier	RCA type 6V6 GT/G		90X6V6GT/G
Voltage regulator	RCA type OD3/VR-150	✓	90XVR150
Rectifier	RCA type 5U4G	✓	90X5U4G
High frequency oscillator	RCA type 955	✓	90X955

INDEX TO PARTS MANUFACTURERS

Symbol	Manufacturer	Symbol	Manufacturer
AL	Alden Manufacturing Co. Brookton, Mass.	IC	Industrial Condenser Corp. Chicago, Illinois
AP	American Phenolic Corp. Chicago, Illinois	IRC	International Resistance Co. Philadelphia, Pennsylvania
CD	Cornell-Dubilier Corp. South Plainfield, N.J.	IF	Littlefuse Inc. Chicago, Illinois
CRL	Centralab Milwaukee, Wis.	O	Omite Manufacturing Co. Chicago, Illinois
CT	Chicago Telephone Supply Elkhart, Indiana	OM	Oak Manufacturing Co. Chicago, Illinois
ER	Erie Resistor Co. Erie, Pennsylvania	RCA	RCA Mfg. Co. Chicago, Illinois
GE	General Electric Co. Schenactady, N.Y.	SI	F. W. Sickles Co. Springfield, Mass.
H	The Hallicrafters Co. Chicago, Illinois	U	Utah Products Co. Chicago, Illinois
HH	Hart & Hegeman Hartford, Conn.		

DULLES AIRPORT
@ 120 mc.

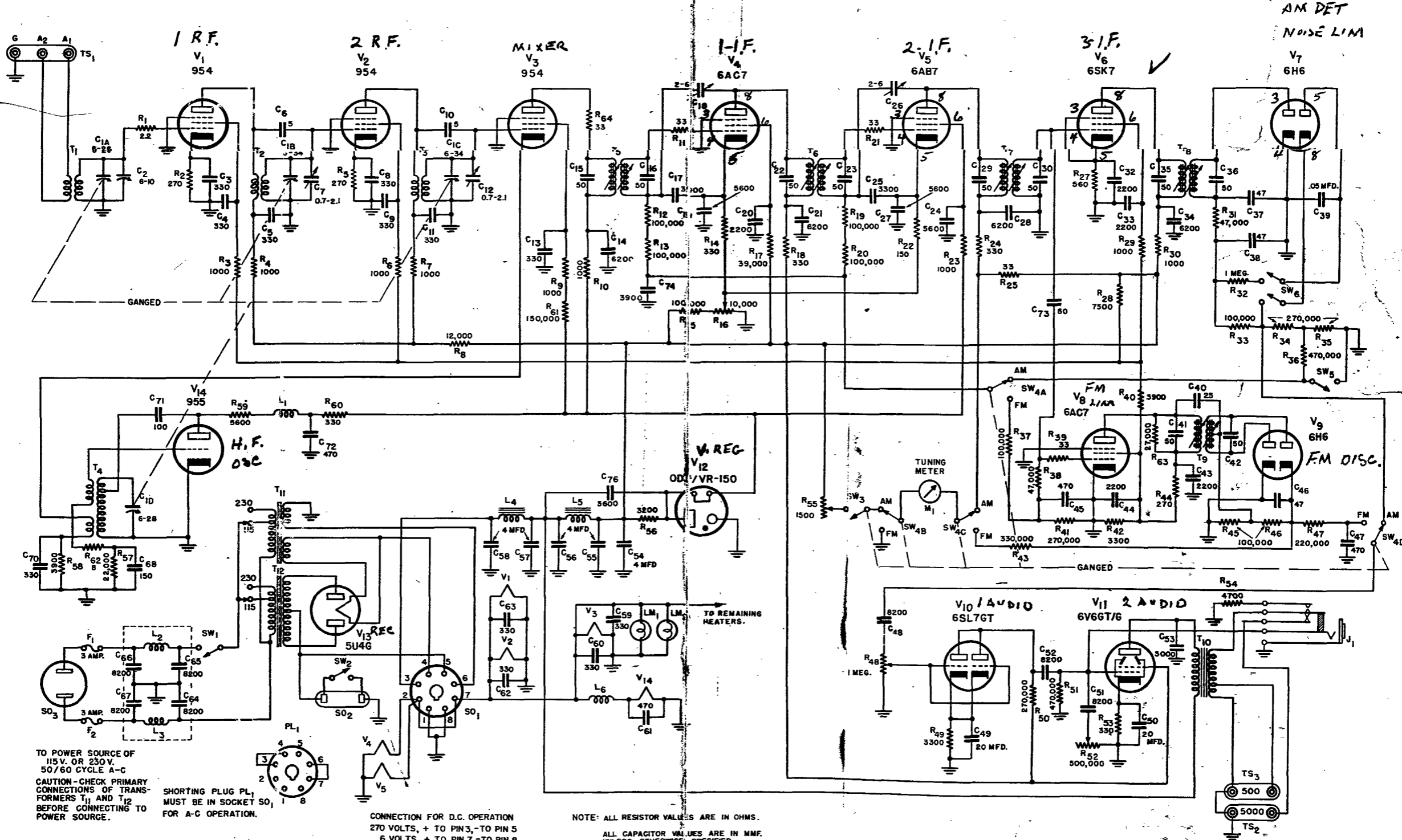

TO POWER SOURCE OF 115V. OR 230V. 50/60 CYCLE A-C
CAUTION - CHECK PRIMARY CONNECTIONS OF TRANSFORMERS T₁₁ AND T₁₂ BEFORE CONNECTING TO POWER SOURCE.

SHORTING PLUG PL₁ MUST BE IN SOCKET SO₁ FOR A-C OPERATION.

CONNECTION FOR D.C. OPERATION
270 VOLTS, + TO PIN 3, - TO PIN 5
6 VOLTS, + TO PIN 7, - TO PIN 8

NOTE: ALL RESISTOR VALUES ARE IN OHMS.
ALL CAPACITOR VALUES ARE IN MMF. UNLESS OTHERWISE SPECIFIED.

- BLK - 0
- BRN - 1
- RED - 2
- ORANGE - 3
- YEL - 4
- GRN - 5
- BLU - 6
- VIOLET - 7
- GRAY - 8
- WHITE - 9

CHECK ALL TUBES NEXT.
Esp. 6H6

Figure 7-7. Radio Receiver Model S-37, schematic wiring diagram.